



CASAMBI



FEATURES

- ◆ CASAMBI LED DIMMER
- ◆ Power input: 12-24-48 Vdc
- ◆ Voltage Output for stripLED and LED module
- ◆ WHITE, MONOCOLOR, DYNAMIC WHITE AND DIM TO WARM Light Control
- ◆ Command: CASAMBI APP
- ◆ Local Command: N°2 Button Normally Open
- ◆ Control voltage output for R
- ◆ Minimum brightness level: down to 0,5%
- ◆ PWM Modulation
- ◆ Frequency PWM 4000Hz
- ◆ Linear / Logarithmic adjustment curve depending on the set Fixture
- ◆ Soft start and soft stop
- ◆ Soft dimming regulation
- ◆ Extended temperature range
- ◆ 100% Functional Test

PRODUCT DESCRIPTION

The SLIM-2CV-CASAMBI is a 2-channel output dimmerLED, controllable via Bluetooth thanks to the Casambi APP or locally through two normally open buttons.

The dimmerLED is suitable for driving loads such as StripLED and LED modules, White, monochromatic colour, Dynamic White and Dim to Warm at constant voltage. It's possible to connect a power supply at 12-24-48 Vdc.

The maximum value of the output current is equal to 10A. The dimmerLED has the following protections: over-power protection, under-power protection, reverse polarity protection and input fuse protection.

Through the CASAMBI APP, the SLIM-2CV-CASAMBI allows you to make from simple brightness adjustments, to more complex lighting control systems, thanks to the creation of multiple scenarios, animations, timers, daylight controls, etc.

The CASAMBI APP can be downloaded for free from the Apple App Store and the Google Play Store.

→ For the always updated manual, consult our website: www.dalcnet.com or QR Code

→ For the correct functioning of the CASAMBI APP, consult the forum on the Casambi website:

<https://support.casambi.com/support/home>



PRODUCT CODE

CODE	SUPPLY VOLTAGE	OUTPUT LED	N° OF CHANNELS	TYPE OF COMMAND
SLIM-2CV-CASAMBI	12-24-48 VDC	2 x 5A (max 10A) ¹	2	APP CASAMBI N°2 Button N.A.

PROTECTIONS

OVP	Over voltage protection ²	✓
UVP	Under voltage protection ²	✓
RVP	Reverse polarity protection ²	✓
IFP	Input fuse protection ²	✓

TYPE OF PROFILES

NAME OF PROFILE	# PROFILE	DESCRIPTION
SLIM 2xDIM (Lin)	24998	N°2 LED output channels, two slides to dim the outputs. PWM frequency = 4000Hz. Linear dimming curve. PWM resolution 1000Step.
SLIM 2xDIM (Log)	23925	N°2 LED output channels, two slides to dim the outputs. PWM frequency = 4000Hz. Logarithmic dimming curve. PWM resolution 1000Step.
SLIM TUNABLE WHITE 2700-6500K	25254	N°2 LED output channels, a slide to dim the TW output and a slide to vary the Color Temperature. PWM frequency = 4000Hz. Linear dimming curve. PWM resolution 1000Step.
SLIM DIM TO WARM	25255	N°2 LED output channels, a single slide to control LED loads DIM to WARM PWM frequency = 4000Hz. PWM resolution 1000Step.

¹ The maximum output current depends on the operating conditions and the ambient temperature of the installation. For the correct configuration, check the maximum deliverable power in the "[Technical Specifications](#)" section and the "[Operating Windows](#)".

² The protections refer to the logical control circuit.

REFERENCE STANDARDS

EN 55015	Limits and methods of measurement of radio disturbance characteristics of electrical lighting and similar equipment
EN 61547	Equipment for general lighting purposes – EMC immunity requirement
EN 61347-1	Lamp Controlgear – Part 1: General and safety requirement
EN 61347-2-13	Lamp Controlgear – Part 2-13: Particular requirement for d.c. or a.c. supplied electronic Controlgear for LED modules

TECHNICAL SPECIFICATIONS

		SLIM 2CV CASAMBI	
Supply voltage		Min: 10,8Vdc – Max: 52,8Vdc	
Output voltage		=Vin	
Input current		Max 10A	
Output current³		2x max 5A	1x max 10A
Nominal power	12 Vdc	60W	120W
	24 Vdc	120W	240W
	48 Vdc	240W	480W
Power loss in standby mode		< 0.5W	
Type of load⁴		R	
Dimming curves		Logarithmic or Linear	
Dimming range⁵		0,5 – 100%	
Minimum dimming level		0,5% (Logarithmic Curve) 0,8% (Linear Curve)	
Dimming method		Pulse Width Modulation "PWM"	
PWM Frequency⁵		4000 Hz	
PWM Resolution⁵		1000 Step	
Operating Frequencies⁵		2402 – 2483 MHz	
Maximum output power⁵		7dBm	
Storage temperature		Min: -40°C – Max: 60°C	
Ambient temperature, Ta range³		Min: -10°C – Max: 60°C	
Type of connector		Push-In terminals	
Wiring	Solid Size	0.2 ÷ 1.5mm ² / 24 ÷ 16 AWG	
	Stranded size		
Wire strip length		9 ÷ 10 mm	
IP protection grade		IP20	
Casing material		Plastic	
Packaging units (pieces/units)		1pcs	
Mechanical dimensions		136 x 29 x 22 mm	
Packaging dimensions		147 x 34 x 29 mm	
Weight		53g	

³ For the full range check the [Operating Window](#) of product.

⁴ Type of load: Resistive and DC/DC Converter.

⁵ The parameters are derived from the configuration of the Casambi module.

WIRING DIAGRAM

As show in the wiring diagram carry out the following steps for the installation of the product:

- Connect the positive of the LED load to the "L1" or "L2" terminals with the "+" symbol, instead the negative of the LED load to the "L1" or "L2" terminals with the "-" symbol.
- Connect the N.O. push button to the "INPUT 1" and "INPUT 2" terminals with the "☐" symbol.
Be sure not to connect live parts to the "INPUT" terminals.
- Connect a 12-24-48 Vdc constant voltage SELV power supply (depending on the technical characteristics of LED load) to the DC IN terminal with the "+" and "-" symbols.
Be sure not to use constant current LED Driver and check that the polarity of the cables is correct.

Like any other product with Bluetooth control, be sure not to place the product inside a metal case or placed near large metal structures. The metal will greatly block the radio signal, important for the correct operation of the device.

CONNECTION SCHEME PROFILE: SLIM 2xDIM

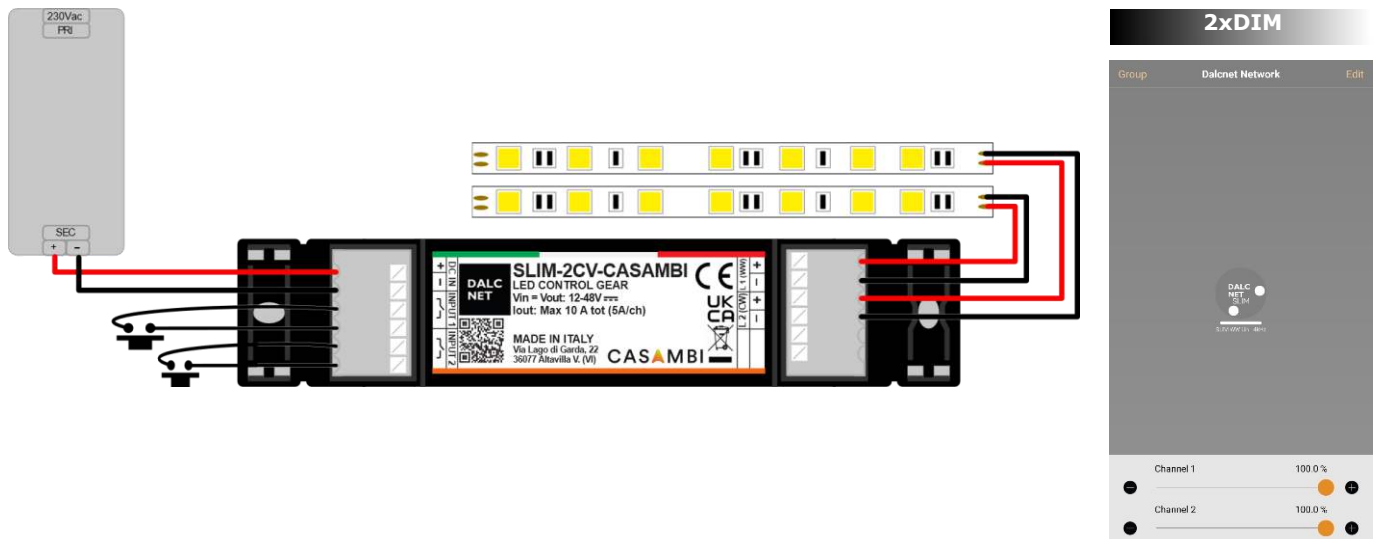



**CONNECTION SCHEME
PROFILE: SLIM TUNABLE WHITE**

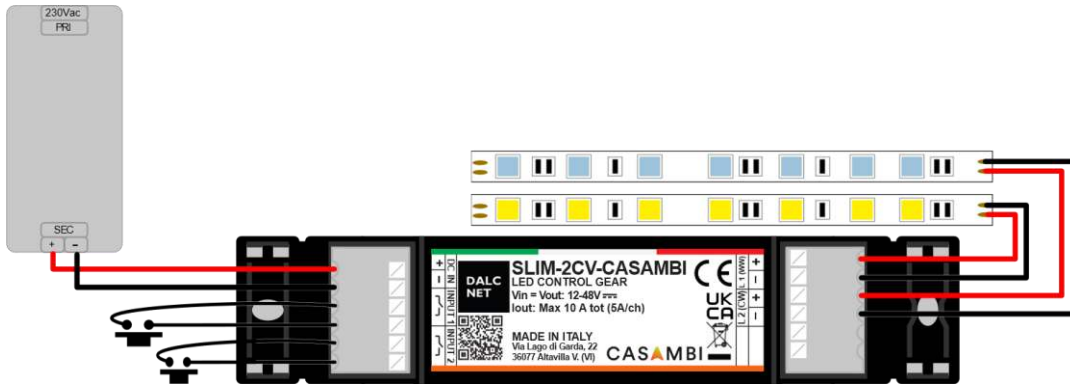

TUNABLE WHITE

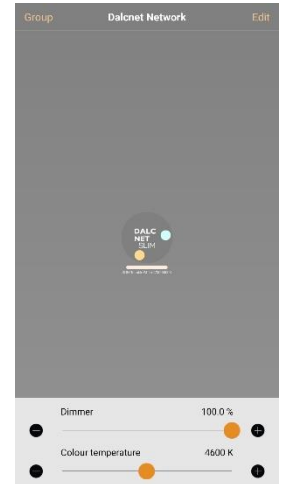

**CONNECTION SCHEME
PROFILE: DIM TO WARM**

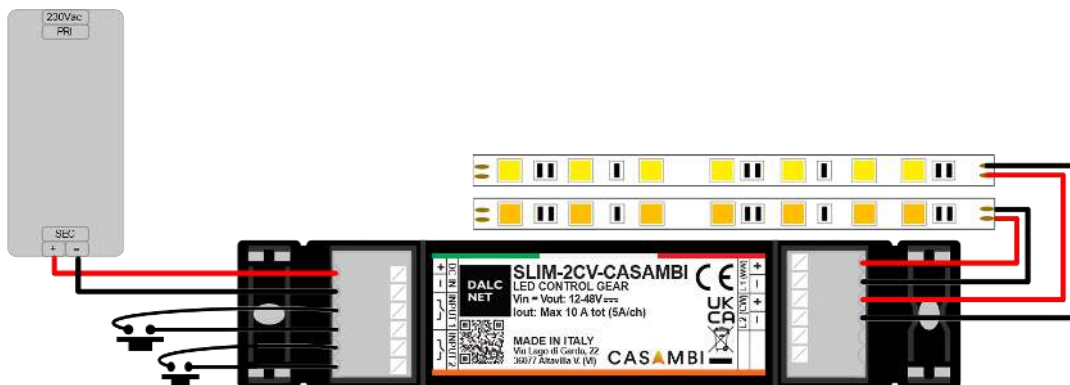

DIM TO WARM

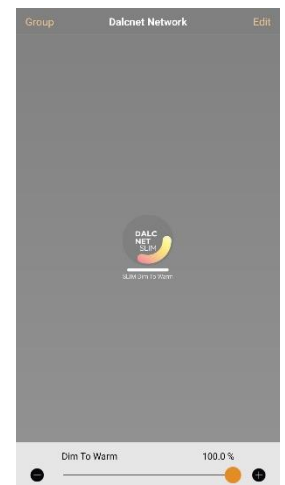

LOCAL COMMANDS FUNCTIONALITY

N.O. PUSH BUTTON⁶

N° Button	Function		
1-2	Controls a luminaire	Click Long pressure (>1s)	Tap to turn a luminaire on or off – hold to adjust luminaire brightness
	Controls an element	Click Long pressure (>1s)	Tap to turn a device element on or off – hold to adjust the element value
	Control a group	Click Long pressure (>1s)	Tap to turn a group on or off – hold to adjust brightness
	Control scene	Click Long pressure (>1s)	Tap to turn a scene on or off – hold to adjust scene brightness
	Control all luminaires	Click Long pressure (>1s)	Tap to turn all luminaires on or off – hold to adjust brightness
	Cycles scenes	Click Long pressure (>1s)	Tap to cycle through the list of scenes – hold to adjust current scene brightness
	Active/Standby	Click Long pressure (>1s)	Tap to switch between two scenes – hold to adjust current scene brightness

For all other functions consult the documentation of the CASAMBI APP at:

<https://support.casambi.com/support/home>

UNPAIR DEVICE FROM THE CASAMBI NETWORK

If the device is associated with a network to which you do not have the credentials and you want to associate it with a new one, follow the settings specified in the Casambi APP in the "Nearby Devices" section. Once you have selected the unpair function and started the procedure, turn off the main power of the power supply connected to the SLIM-2CV-CASAMBI and turn it on again after 1 - 2 seconds.

If the main power supply is switched off and on again quickly, unpair may not be done properly. Repeat the unpair sequence by allowing 1 or 2 more seconds to elapse between the moment you turn off and re-turn on the main power of the power supply⁷.

A second method to unpair the product is to connect an N.O. push button to an "INPUT" terminal of the SLIM-2CV-CASAMBI and during the decoupling procedure press the button.

⁶ By default, the N.O. Push button is set as "Control a luminaire" and controls the outputs of the SLIM-2CV-CASAMBI.

⁷ The discharge time of the power supply secondary depends on the construction characteristics of the power supply used.

OPERATING WINDOW

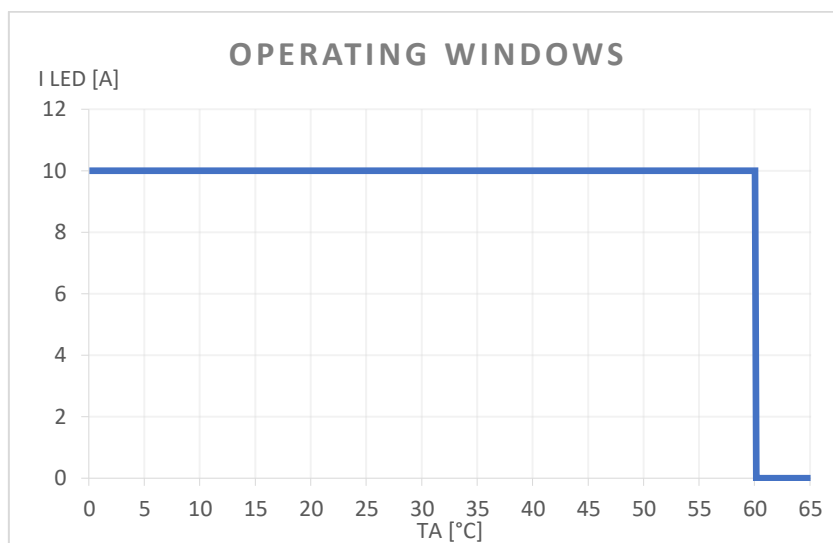

Ambient temperature [Ta]:

- provides a current up to 10A, with a working temperature range of -10°C ÷ +60°C.

These maximum current values can be applied only under proper ventilation conditions.

FLICKER PERFORMANCE

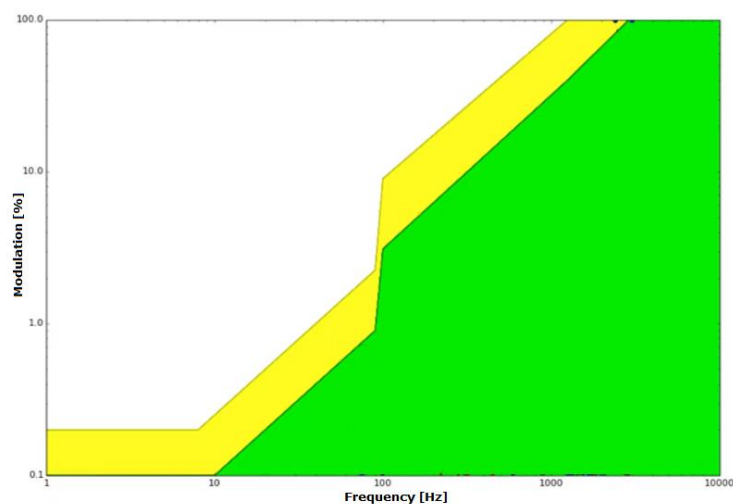

Thanks to the 4kHz dimming frequency the SLIM-2CV-CASAMBI allows to reduce the Flicker phenomenon.

Depending on the sensitivity of a person and type of activity, Flickering can affect a person's well-being even if the luminance fluctuations are above the threshold that can be perceived by the human eye.

The graph shows the phenomenon of Flickering in function at the frequency, measured throughout the dimming range.

The results show the low-risk zone (yellow) and the no-effect zone (green). Defined by IEEE 1789-2015⁸

⁸ Institute of Electrical and Electronics Engineers (IEEE). *IEEE std 1789: Recommended Practices for Modulating Current in High-Brightness LEDs for Mitigating Health Risks to Viewers.*

DIMMING CURVE

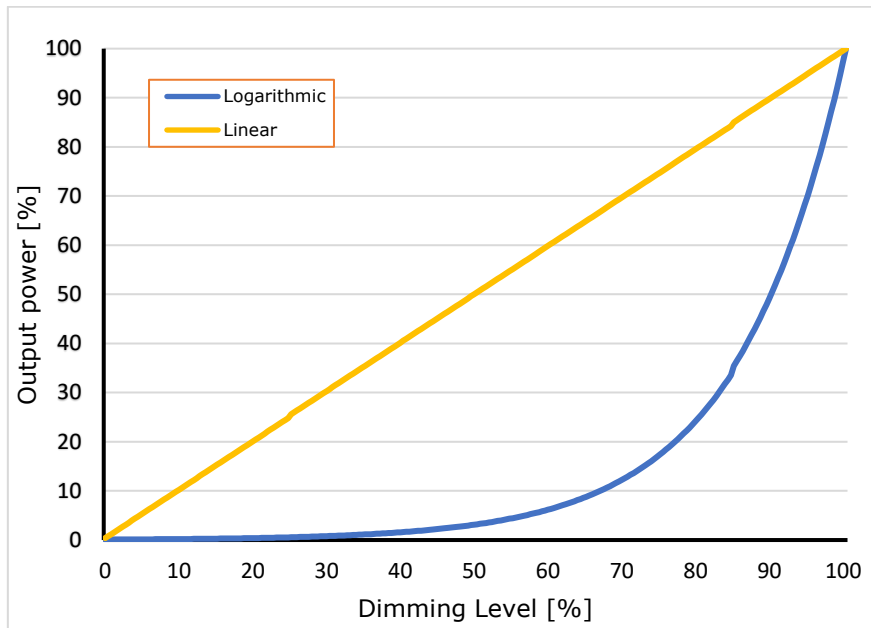

MECHANICAL DIMENSIONS

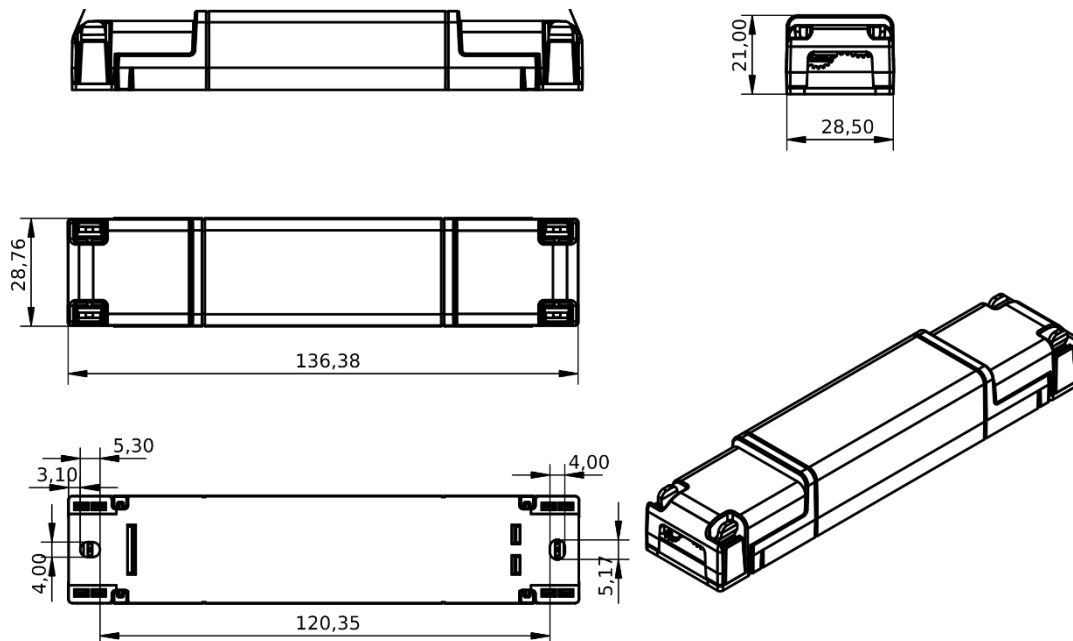

TECHNICAL NOTE

INSTALLATION

- **CAUTION:** The product may only be connected and installed by a qualified electrician. All applicable regulations, legislation, and building codes must be observed. Incorrect installation of the product can cause irreparable damage to the product and the connected LEDs.
- Maintenance must be performed only by a qualified electrician in compliance with current regulations.
Pay attention when connecting the LEDs: polarity reversal results in no light output and often damages the LEDs.
- The product is designed and intended to operate LED loads only. Powering non-LED loads may push the product outside its specified design limits and is, therefore, not covered by any warranty.
Operating conditions of the product may never exceed the specifications as per the product datasheet.
- The product must be installed inside a switchgear/controlgear cabinet and/or junction box protection against overvoltage.
- The product must be installed in a vertical or horizontal position with the label/top cover facing upwards or vertically. Other positions are not permitted. The bottom position is not permitted (label/top cover facing down).
- Keep separated 230Vac (LV) circuits and not SELV circuit from safety extra low voltage (SELV) circuit and from any connection with this product. It is absolutely forbidden to connect, for any reason whatsoever, directly or indirectly, the 230Vac mains voltage to the product (terminal block of BUS included).
- The product must be dissipated correctly.
- The use of the product in harsh environments could limit the output power.
- For built-in components inside luminaires, the ta ambient temperature range is a guideline given for the optimum operating environment. However, integrator must always ensure proper thermal management (i.e. correct mounting of the device, air flow etc.) so that the tc point temperature does not exceed the tc maximum limit in any circumstance. Reliable operation and lifetime is only guaranteed if the maximum tc point temperature is not exceeded under the conditions of use.

POWER SUPPLY

- Only use SELV power supplies with limited current for device power supply, short circuit protection and the power must be dimensioned correctly.
In the case of power supplies equipped with ground terminals, it is mandatory to connect ALL protective ground points (PE= Protection Earth) to a properly and certified protection earth.
- The connection cables between the very low voltage power source and the product must be properly dimensioned and must be insulated from any wiring or part at non-SELV voltage. Use double insulated cables.
- Dimension the power of the power supply in relation to the load connected to the device. In case the power supply is oversized compared to the maximum absorbed current, insert a protection against over-current between the power supply and the device.

COMMAND

- The length of the cables connecting between the local commands (N.O. Push button or other) and the product must be less than 10m. The cables must be properly dimensioned and must be insulated from any non-SELV wiring or voltage. It is recommended to use double insulated cables, if deemed appropriate also shielded.
- ALL device and control signal connected to the local command "N.O. Push button" with  symbol, they must not supply any type of voltage.

OUTPUTS

- It is recommended a length of the connecting cables between the product and the LED module less than 10m. The cables must be properly dimensioned and must be insulated from any wiring or circuits at voltage not SELV. It is recommended to use double insulated cables. In case you want to use connecting cables between the product and the LED module greater than 10m, the installer must guarantee the correct operation of the system. In any case, the connection between the product and the LED module must not exceed 30m.

ONLY CASAMBI/BLUETTOTH PRODUCT

- **WARNING:** For optimal functionality of the Casambi signal, do not put the device into metal or aluminium boxes and do not shield the device. As any other Casambi product, should not be placed in a metal enclosure or next to large metal structures. Metal will effectively block all radio signals which are crucial to the operation of the product.

WARNINGS

- To guarantee the best performances and the full use of functions, make sure to download on your device the last release of CASAMBI APP.
- Whenever CASAMBI APP requires an upgrade of the profile installed in the LED Dimmers, follow the instruction to do it. This allows you to stay always up to date and benefit of new functions released.
- Functionality test are done on all dimmers to ensure the right working. In case the device is still paired to "Dalcnet network", you are asked to unpair it by following the instructions on CASAMBI APP and in paragraph ["UNPAIR DEVICE FROM THE CASAMBI NETWORK"](#).