



CASAMBI



FEATURES

- ◆ CASAMBI LED DIMMER
- ◆ Power Supply: 12-24-48 Vdc
- ◆ Voltage output for LED strip and LED module
- ◆ Control of the White and Monochromatic Light
- ◆ Command: APP CASAMBI
- ◆ Local Command: n°1 Normal Open Push Button
- ◆ Control voltage outputs for R
- ◆ Adjusting the brightness up to completed off (Dim to Dark)
- ◆ Minimum Brightness level: down to 0,1%
- ◆ PWM Modulation
- ◆ Adjusting PWM frequency: 600 / 4000 Hz
- ◆ Adjusting output curve: Linear / Logarithmic
- ◆ Soft start and soft stop
- ◆ Soft Dimming regulation
- ◆ Extended temperature range
- ◆ 100% Functional test

PRODUCT DESCRIPTION

MINI-1CV-CASAMBI is a single channel LED dimmer, controllable via Bluetooth using the Casambi APP or locally with a normally open push button.

The LED dimmer is suitable for driving Strip LED and LED modules, White and monochromatic constant voltage loads. It is possible to connect a power supply at 12-24-48 Vdc.

The maximum total output current is 12A. The LED dimmer has over voltage protection, under voltage protection, reverse polarity protection and input fuse protection.

By means of the CASAMBI APP, the MINI-1CV-CASAMBI allows you to make a variety of effects: from simple brightness adjustments to more complex lighting control system, thanks to the creation of multiple scenarios, animations, timers, daylight control etc.

CASAMBI APP can be downloaded for free on Apple App Store and Google Play Store.

→ For the up-to-date manual, please visit our website: www.dalcnet.com or scan the QR Code located on the product's label.

→ For the correct functioning of the CASAMBI APP, please visit the forum on the Casambi website:

<https://support.casambi.com/support/home>



PRODUCT CODE

CODE	POWER SUPPLY	OUTPUT LED	N° OF CHANNEL	TYPE OF COMMAND
MINI-1CV-CASAMBI	12-24-48 VDC	1 x 12A ¹	1	APP CASAMBI N°1 N.O. PUSH BUTTON

PROTECTIONS

OVP	Over voltage protection ²	✓
UVP	Under voltage protection ²	✓
RVP	Reverse polarity protection ²	✓
IFP	Input fuse protection ²	✓

TYPE OF PROFILE

NAME OF PROFILE	# PROFILE	DESCRIPTION
MINI 4kHz (Lin)	9531	One channel PWM dimmer Output PWM Frequency = 4000Hz Linear dimming curve PWM resolution 1000step
MINI 4kHz (Log)	23372	One channel PWM dimmer Output PWM Frequency = 4000Hz Logarithmic dimming curve PWM resolution 1000step
MINI 600Hz (Lin)	24661	One channel PWM dimmer Output PWM Frequency = 600Hz Linear dimming curve PWM resolution 1666step
MINI 600Hz (Log)	22989	One channel PWM dimmer Output PWM Frequency = 600Hz Logarithmic dimming curve PWM resolution 1666step

¹ The maximum output current depends on the operating conditions and the ambient temperature of the installation. For the correct configuration, check the maximum deliverable power in the "[Technical Specifications](#)" section and the "[Operating Window](#)"

² The protections refer to the logical control circuit.

REFERENCE STANDARDS

EN 55015	Limits and methods of measurement of radio disturbance characteristics of electrical lighting and similar equipment
EN 61547	Equipment for general lighting purposes – EMC immunity requirement
EN 61347-1	Lamp Controlgear – Part 1: General and safety requirement
EN 61347-2-13	Lamp Controlgear – Part 2-13: Particular requirement for d.c. or a.c. supplied electronic Controlgear for LED modules

TECHNICAL SPECIFICATION

		MINI 1 CV CASAMBI
Supply voltage		Min: 10,8Vdc – Max: 52,8Vdc
Output voltage		=Vin
Input current		Max 12A
Output current³		max 12A @40°C – max 10A @60°C
Nominal Power	12 Vdc	144W @12A – 120W @10A
	24 Vdc	288W @12A – 240W @10A
	48 Vdc	576W @12A – 480W @10A
Power loss in standby mode		< 0,5W
Type of load⁴		R
Dimming curve		Logarithmic or Linear
Dimming range⁵		0,1 – 100%
Minimum dimming level		0,1% (Logarithmic curve 600Hz) ⁶
		0,4% (Linear curve 600Hz)
Dimming method		0,5% (Logarithmic curve 4kHz)
		0,5% (Linear curve 4kHz)
Dimming method		Pulse Width Modulation "PWM"
PWM frequency⁵		600 – 4000 Hz
PWM resolution⁵		1666 Step (600Hz) 1000 Step (4kHz)
Operating frequencies⁵		2402 – 2480 MHz
Maximum output power⁵		7dBm
Storage temperature		Min: -40°C – Max: 60°C
Ambient temperature, Ta range³		Min: -10°C – Max: 60°C
Connector type		Screw terminals
Wiring	Solid Size	0,05 ÷ 2,5 mm ² / 30 ÷ 12 AWG
	Stranded size	
Wire strip length		6,5 mm
IP protection grade		IP20
Casing material		Plastic
Packaging unit (pieces/unit)		1pcs
Mechanical dimension		44 x 57 x 25 mm
Packaging dimension		56 x 68 x 35 mm
Weight		44g

³ For the complete range, see the [Operating Window](#) of the product.

⁴ Type of load: Resistive and DC/DC Converter.

⁵ The parameters are derived from the configuration of the Casambi module.

⁶ Dim to Dark Dimming.

WIRING DIAGRAM

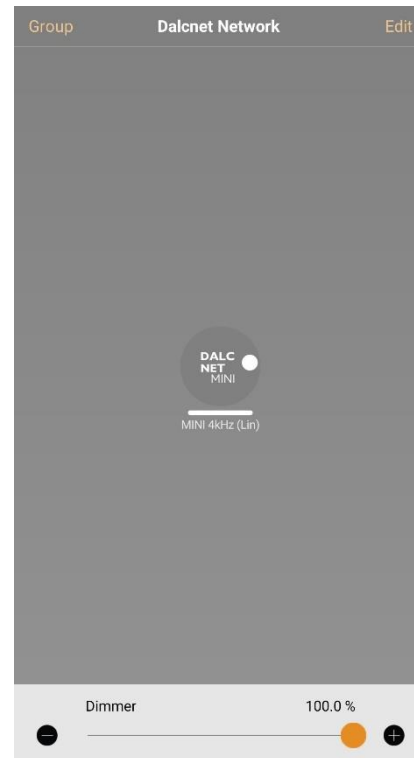
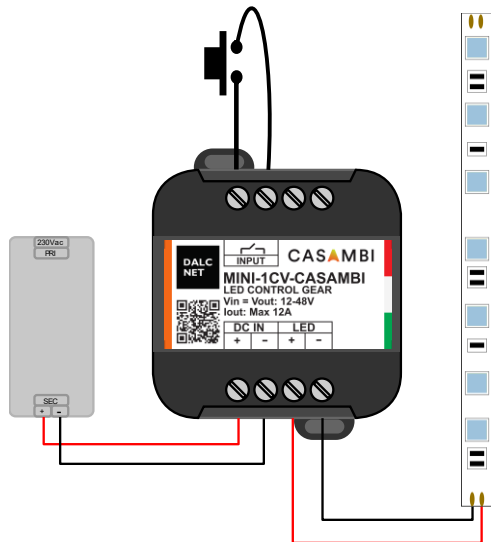

As show in the wiring diagram carry out the following steps for the installation of the product

- ◆ Connect the positive of the LED load to the "LED" terminals with the "+" symbol, and the negative of the LED load to the "LED" terminals with the "-" symbol.
- ◆ Connect the N.O. push button to the "INPUT" terminals with the "☐☐" symbol.
Be sure not to connect live parts to the "INPUT" terminals.
- ◆ Connect a 12-24-48 Vdc constant voltage SELV power supply (depending on the technical characteristics of LED load) to the "DC IN" terminal with the "+" and "-" symbols.
Be sure not to use constant current LED Driver and check that the polarity of the cables is correct.

Like any other product with Bluetooth control, be sure not to place the product inside a metal case or next to large metal structures. The metal will greatly block the radio signal, important for the correct operation of the device.

LOCAL COMMANDS FUNCTIONALITY

N.O. PUSH BUTTON⁷

N° Push Button	Functions		
1	Controls a luminaire	Click Long press (>1s)	Tap to turn a luminaire on or off – hold to adjust luminaire brightness
	Controls an element	Click Long press (>1s)	Tap to turn a device element on or off – hold to adjust the element value
	Control a group	Click Long press (>1s)	Tap to turn a group on or off – hold to adjust brightness
	Control scene	Click Long press (>1s)	Tap to turn a scene on or off – hold to adjust scene brightness
	Control all luminaires	Click Long press (>1s)	Tap to turn all luminaires on or off – hold to adjust brightness
	Cycles scenes	Click Long press (>1s)	Tap to cycle through the list of scenes – hold to adjust current scene brightness
	Active/Standby	Click Long press (>1s)	Tap to switch between two scenes – hold to adjust current scene brightness

For all other functions, please refer to the CASAMBI APP document at:

<https://support.casambi.com/support/home>

UNPAIR DEVICE FROM THE CASAMBI NETWORK

If the device is associated with a network to which you do not have the credentials and you want to associate it with a new one, follow the settings specified in the Casambi APP in the "Nearby Devices" section. Once you have selected the unpair function and started the procedure, turn off the main power of the power supply connected to the MINI-1CV-CASAMBI and turn it on again after 1 - 2 seconds.

If the main power supply is switched off and on again quickly, unpair may not be done properly. Repeat the unpair sequence by allowing 1 or 2 more seconds to elapse between the moment you turn off and re-turn on the main power of the power supply⁸.

A second method to unpair the product is to connect an N.O. push button to an "INPUT" terminal of the MINI-1CV-CASAMBI and during the decoupling procedure press the button.

⁷ By default, the N.O. Push button is set as "Control a luminaire" and controls the output of the MINI-1CV-CASAMBI.

⁸ The discharge time of the power supply secondary depends on the construction characteristics of the power supply used.

OPERATING WINDOW

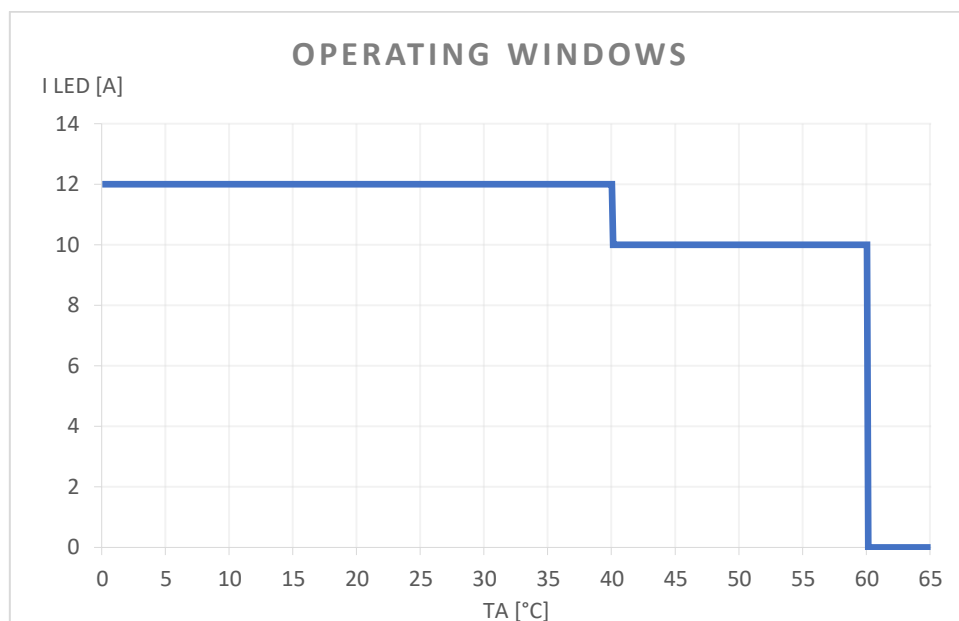

Ambient temperature [Ta]:

- provides a current up to 12A, with a working temperature range of $-10^{\circ}\text{C} \div +40^{\circ}\text{C}$.
- provides a current up to 10A, with a working temperature range of $+40^{\circ}\text{C} \div +60^{\circ}\text{C}$.

These maximum current values can be applied only under proper ventilation conditions.

FLICKER PERFORMANCE

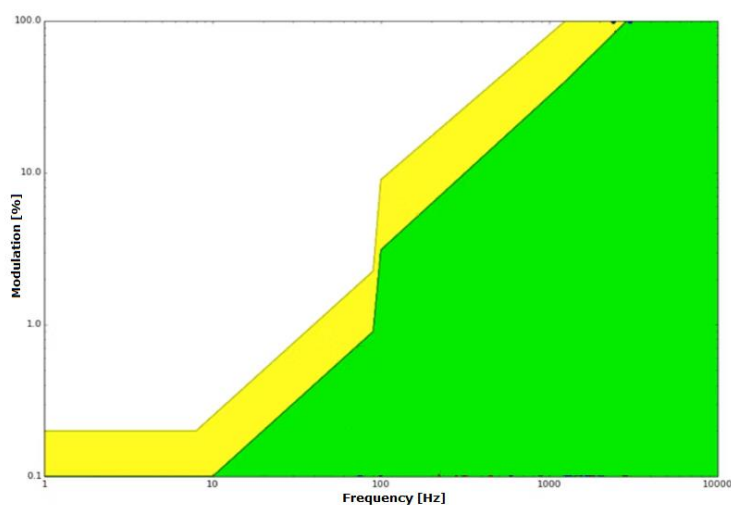

Thanks to the 4kHz dimming frequency the MINI-1CV-CASAMBI allows to reduce the Flicker phenomenon. Depending on the sensitivity of a person and the type of activity, flickering can affect a person's well-being even if the luminance fluctuations are above the threshold that can be perceived by the human eye.

The graph shows the phenomenon of Flickering in function at the frequency, measured throughout the dimming range.

The results show the low-risk zone (yellow) and the no-effect zone (green). Defined by IEEE 1789-2015⁹

⁹ Institute of Electrical and Electronics Engineers (IEEE). *IEEE std 1789: Recommended Practices for Modulating Current in High-Brightness LEDs for Mitigating Health Risks to Viewers.*

DIMMING CURVE

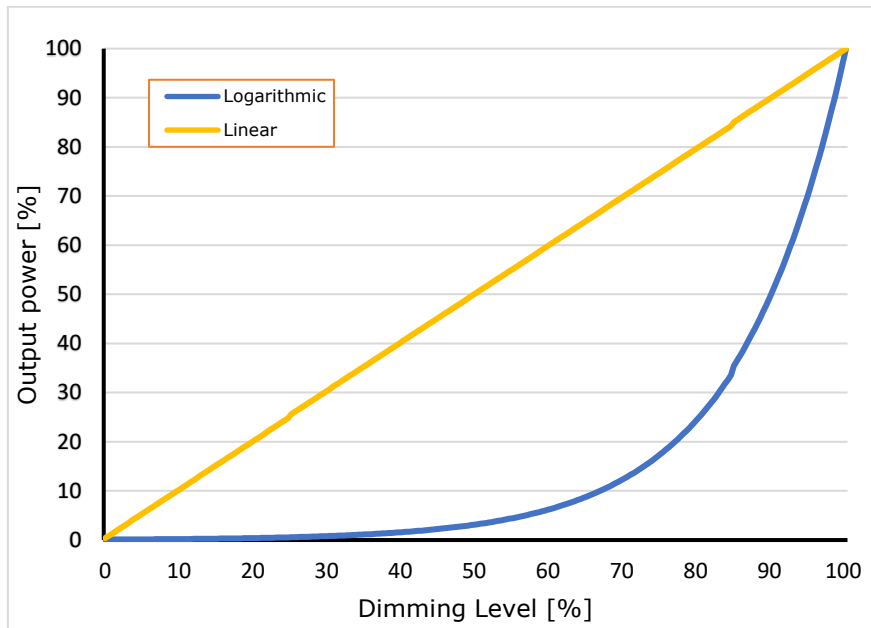

MECHANICAL DIMENSION

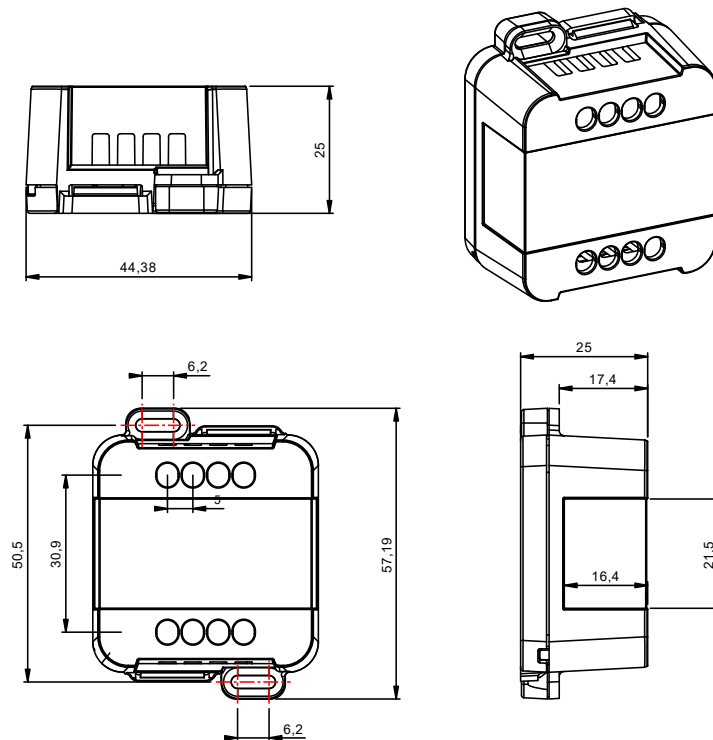

TECHNICAL NOTE

INSTALLATION

- CAUTION: The product may only be connected and installed by a qualified electrician. All applicable regulations, legislation, and building codes must be observed. Incorrect installation of the product can cause irreparable damage to the product and the connected LEDs.
- Maintenance must be performed only by a qualified electrician in compliance with current regulations.
Pay attention when connecting the LEDs: polarity reversal results in no light output and often damages the LEDs.
- The product is designed and intended to operate LED loads only. Powering non-LED loads may push the product outside its specified design limits and is, therefore, not covered by any warranty.
Operating conditions of the product may never exceed the specifications as per the product datasheet.
- The product must be installed inside a switchgear/controlgear cabinet and/or junction box protection against overvoltage.
- The product must be installed in a vertical or horizontal position with the label/top cover facing upwards or vertically. Other positions are not permitted. The bottom position is not permitted (label/top cover facing down).
- Keep separated 230Vac (LV) circuits and not SELV circuit from safety extra low voltage (SELV) circuit and from any connection with this product. It is absolutely forbidden to connect, for any reason whatsoever, directly or indirectly, the 230Vac mains voltage to the product (terminal block of BUS included).
- The product must be dissipated correctly.
- The use of the product in harsh environments could limit the output power.
- For built-in components inside luminaires, the ta ambient temperature range is a guideline given for the optimum operating environment. However, integrator must always ensure proper thermal management (i.e. correct mounting of the device, air flow etc.) so that the tc point temperature does not exceed the tc maximum limit in any circumstance. Reliable operation and lifetime is only guaranteed if the maximum tc point temperature is not exceeded under the conditions of use.

POWER SUPPLY

- Only use SELV power supplies with limited current for device power supply, short circuit protection and the power must be dimensioned correctly.
In the case of power supplies equipped with ground terminals, it is mandatory to connect ALL protective ground points (PE= Protection Earth) to a properly and certified protection earth.
- The connection cables between the very low voltage power source and the product must be properly dimensioned and must be insulated from any wiring or part at non-SELV voltage. Use double insulated cables.
- Dimension the power of the power supply in relation to the load connected to the device. In case the power supply is oversized compared to the maximum absorbed current, insert a protection against over-current between the power supply and the device.

COMMAND

- The length of the cables connecting between the local commands (N.O. Push button or other) and the product must be less than 10m. The cables must be properly dimensioned and must be insulated from any non-SELV wiring or voltage. It is recommended to use double insulated cables, if deemed appropriate also shielded.
- ALL device and control signal connected to the local command "N.O. Push button" with  symbol, they must not supply any type of voltage.

OUTPUTS

- It is recommended a length of the connecting cables between the product and the LED module less than 10m. The cables must be properly dimensioned and must be insulated from any wiring or circuits at voltage not SELV. It is recommended to use double insulated cables. In case you want to use connecting cables between the product and the LED module greater than 10m, the installer must guarantee the correct operation of the system. In any case, the connection between the product and the LED module must not exceed 30m.

ONLY CASAMBI/BLUETTOTH PRODUCT

- WARNING: For optimal functionality of the Casambi signal, do not put the device into metal or aluminium boxes and do not shield the device. As any other Casambi product, should not be placed in a metal enclosure or next to large metal structures. Metal will effectively block all radio signals which are crucial to the operation of the product.

WARNINGS

- To guarantee the best performances and the full use of functions, make sure to download on your device the last release of CASAMBI APP.
- Whenever CASAMBI APP requires an upgrade of the profile installed in the LED Dimmers, follow the instruction to do it. This allows you to stay always up to date and benefit of new functions released.
- Functionality test are done on all dimmers to ensure the right working. In case the device is still paired to "Dalcnet network", you are asked to unpair it by following the instructions on CASAMBI APP and in paragraph ["UNPAIR DEVICE FROM THE CASAMBI NETWORK"](#).