

M12 Circular connectors

Male cable

Product figure



Scale diagram

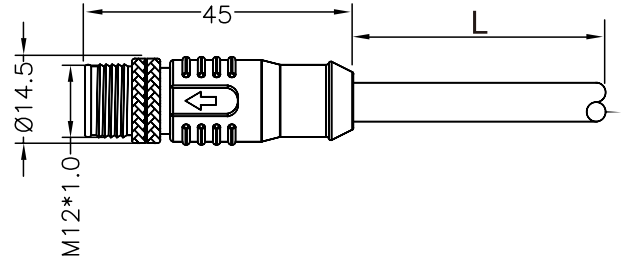

Contact layout/针孔排布 (Front view/前视图)

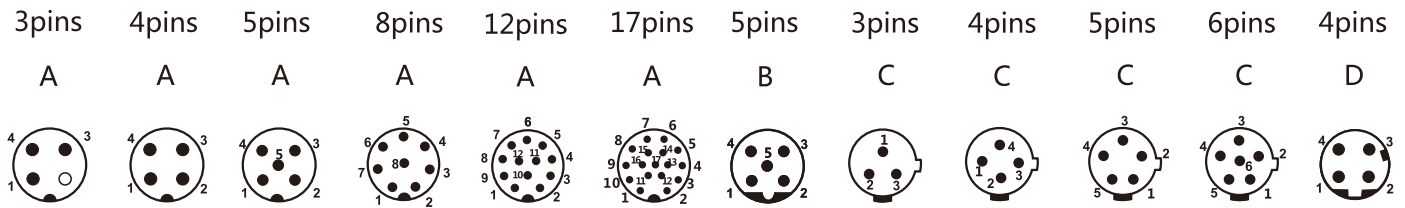

Order Data/订货信息

Contacts/芯数	Coding	Order No/订货号	P/N/料号
3pins	A	120103-05-002	CAM12SAM03001
	C	120303-05-002	CAM12SCM03001
4pins	A	120104-05-003	CAM12SAM04001
	C	120304-05-003	CAM12SCM04001
	D	120404-05-002	CAM12SDM04001
5pins	A	120105-05-002	CAM12SAM05001
	B	120205-05-002	CAM12SBM05001
	C	120305-05-002	CAM12SCM05001
6pins	C	120305-05-002	CAM12SCM05001
8pins	A	120108-05-002	CAM12SAM08001
12pins	A	120112-05-002	CAM12SAM12001
17pins	A	120117-05-002	CAM12SAM17001

Specifications/技术参数

Number of contacts/芯数	3	4	5	8	12	17
Termination/接线方式	moulded on cable/成型线					
Wire gauge/线规	0.14/0.25/0.34/0.5mm ² / (26/24/22/20 AWG)					
Operating temperature/工作温度	-25°C~ +80°C					
Mechanical operation/插拔次数	> 100 mating cycles					
Rated voltage/额定电压	250V		60V		30V	
Rated current (40°C)/额定电流	4A			2A		1.5A
Protection degree/防护等级	IP67/IP68					
Contact resistance/接触电阻	< 10mΩ					
Insulation resistance/绝缘电阻	≥100MΩ					
Pin contact/插针材料	CuZn					
Socket contact/插孔材料	CuSn					
Contact plating/针孔镀层材料	Au					

M12 Circular connectors

Female cable

Product figure



Scale diagram

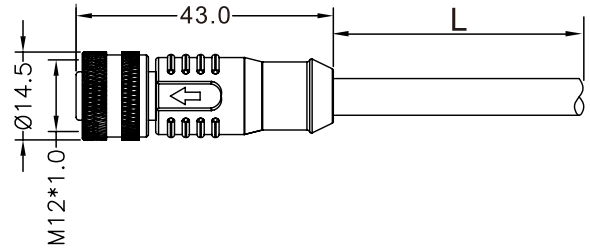

Contact layout/针孔排布 (Front view/前视图)

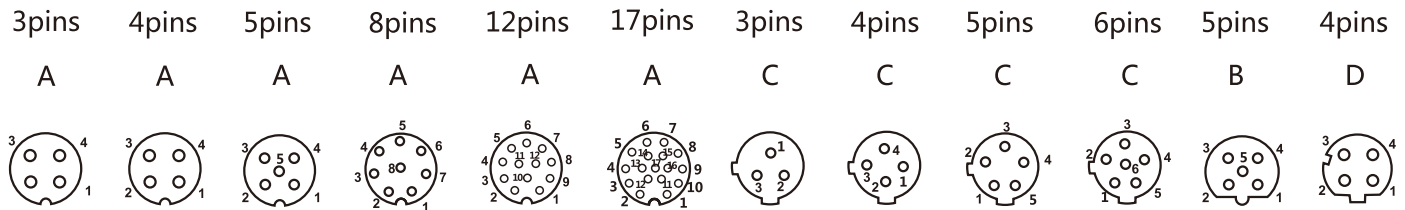

Order Data/订货信息

Contacts/芯数	Coding	Order No/订货号	P/N/料号
3pins	A	120103-06-004	CAM12SAF03001
	C	120303-06-002	CAM12SCF03001
4pins	A	120104-06-004	CAM12SAF04001
	C	120304-06-002	CAM12SCF04001
	D	120404-06-002	CAM12SDF04001
5pins	A	120105-06-004	CAM12SAF05001
	B	120205-06-002	CAM12SBF05001
	C	120305-06-002	CAM12SCF05001
6pins	C	120306-06-002	CAM12SCF06001
8pins	A	120108-06-002	CAM12SAF08001
12pins	A	120112-06-002	CAM12SAF12001
17pins	A	120117-06-002	CAM12SAF17001

Specifications/技术参数

Number of contacts/芯数	3	4	5	8	12	17
Termination/接线方式	moulded on cable/成型线					
Wire gauge/线规	0.14/0.25/0.34/0.5mm ² / (26/24/22/20 AWG)					
Operating temperature/工作温度	-25°C ~ +80°C					
Mechanical operation/插拔次数	> 100 mating cycles					
Rated voltage/额定电压	250V		60V		30V	
Rated current (40°C)/额定电流	4A			2A		1.5A
Protection degree/防护等级	IP67/IP68					
Contact resistance/接触电阻	< 10mΩ					
Insulation resistance/绝缘电阻	≥ 100MΩ					
Pin contact/插针材料	CuZn					
Socket contact/插孔材料	CuSn					
Contact plating/针孔镀层材料	Au					

M12 Circular connectors

Male cable (with shield)

Product figure



Scale diagram

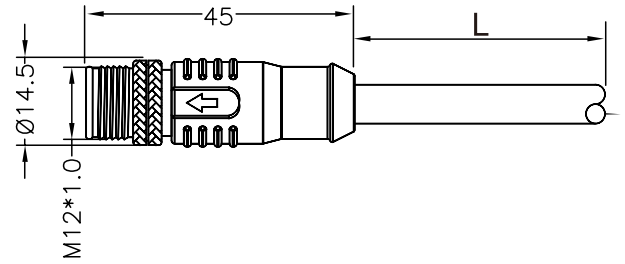

Contact layout/针孔排布 (Front view/前视图)

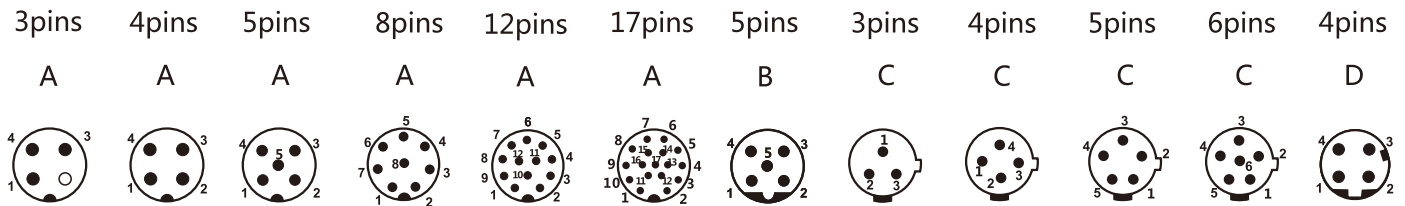

Order Data/订货信息

Contacts/芯数	Coding	Order No/订货号	P/N/料号
3pins	A	120103-05-003	CAM12SAM03002
	C	120303-05-003	CAM12SCM03002
4pins	A	120104-05-004	CAM12SAM04002
	C	120304-05-003	CAM12SCM04002
	D	120404-05-003	CAM12SDM04002
5pins	A	120105-05-003	CAM12SAM05002
	B	120205-05-003	CAM12SBM05002
	C	120305-05-003	CAM12SCM05002
6pins	C	120306-05-003	CAM12SCM06002
8pins	A	120108-05-003	CAM12SAM08002
12pins	A	120112-05-003	CAM12SAM12002
17pins	A	120117-05-003	CAM12SAM17002

Specifications/技术参数

Number of contacts/芯数	3	4	5	8	12	17
Termination/接线方式	moulded on cable/成型线					
Wire gauge/线规	0.14/0.25/0.34/0.5mm ² / (26/24/22/20 AWG)					
Operating temperature/工作温度	-25°C ~ +80°C					
Mechanical operation/插拔次数	> 100 mating cycles					
Rated voltage/额定电压	250V		60V		30V	
Rated current (40°C)/额定电流	4A			2A		1.5A
Protection degree/防护等级	IP67/IP68					
Contact resistance/接触电阻	< 10mΩ					
Insulation resistance/绝缘电阻	≥ 100MΩ					
Pin contact/插针材料	CuZn					
Socket contact/插孔材料	CuSn					
Contact plating/针孔镀层材料	Au					

M12 Circular connectors

Female cable (with shield)

Product figure



Scale diagram

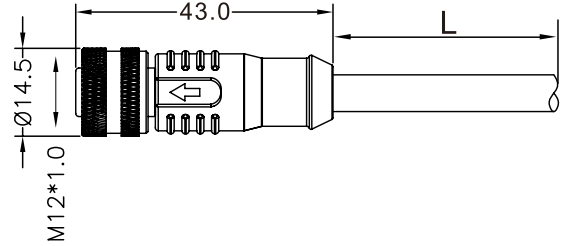

Contact layout/针孔排布 (Front view/前视图)

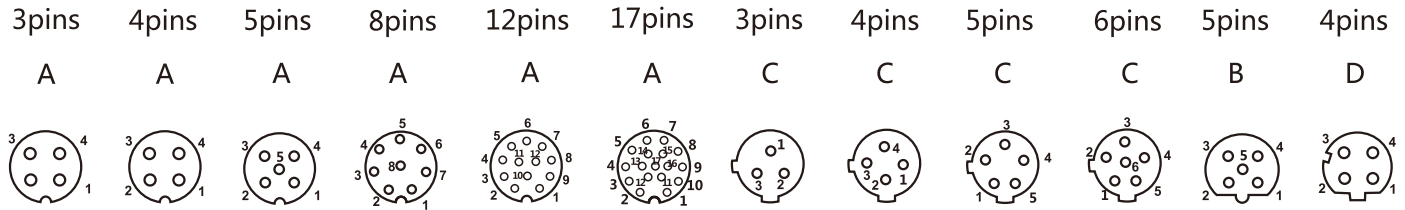

Order Data/订货信息

Contacts/芯数	Coding	Order No/订货号	P/N/料号
3pins	A	120103-06-005	CAM12SAF03002
	C	120303-06-003	CAM12SCF03002
4pins	A	120104-06-005	CAM12SAF04002
	C	120304-06-003	CAM12SCF04002
	D	120404-06-003	CAM12SDF04002
5pins	A	120105-06-005	CAM12SAF05002
	B	120205-06-003	CAM12SBF05002
	C	120305-06-003	CAM12SCF05002
6pins	C	120306-06-003	CAM12SCF06002
8pins	A	120108-06-003	CAM12SAF08002
12pins	A	120112-06-003	CAM12SAF12002
17pins	A	120117-06-003	CAM12SAF17002

Specifications/技术参数

Number of contacts/芯数	3	4	5	8	12	17
Termination/接线方式	moulded on cable/成型线					
Wire gauge/线规	0.14/0.25/0.34/0.5mm ² / (26/24/22/20 AWG)					
Operating temperature/工作温度	-25°C ~ +80°C					
Mechanical operation/插拔次数	> 100 mating cycles					
Rated voltage/额定电压	250V		60V		30V	
Rated current (40°C)/额定电流	4A			2A		1.5A
Protection degree/防护等级	IP67/IP68					
Contact resistance/接触电阻	< 10mΩ					
Insulation resistance/绝缘电阻	≥100MΩ					
Pin contact/插针材料	CuZn					
Socket contact/插孔材料	CuSn					
Contact plating/针孔镀层材料	Au					

M12 Circular connectors

Male cable (90°)

Product figure



Scale diagram

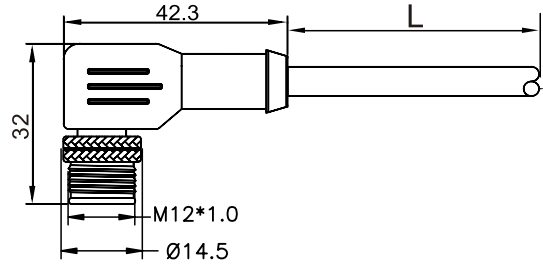

Contact layout/针孔排布 (Front view/前视图)

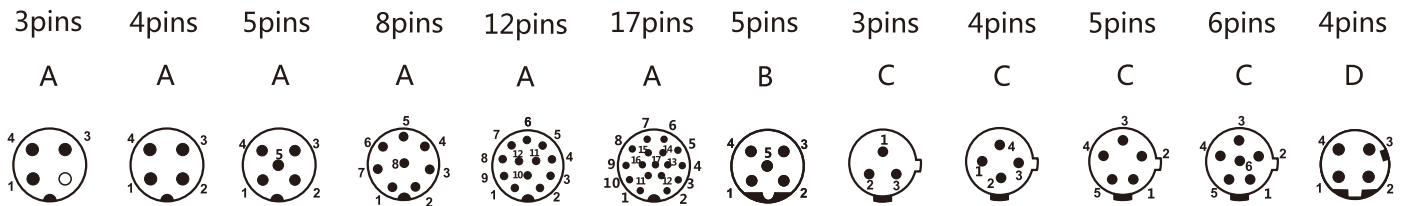

Order Data/订货信息

Contacts/芯数	Coding	Order No/订货号	P/N/料号
3pins	A	120103-05-001	CAM12RAM03003
	C	120303-05-001	CAM12RCM03003
4pins	A	120104-05-001	CAM12RAM04003
	C	120304-05-001	CAM12RCM04003
	D	120404-05-001	CAM12RDM04003
5pins	A	120105-05-001	CAM12RAM05003
	B	120205-05-001	CAM12RBM05003
	C	120305-05-001	CAM12RCM05003
6pins	C	120306-05-001	CAM12RCM06003
8pins	A	120108-05-001	CAM12RAM08003
12pins	A	120112-05-001	CAM12RAM12003
17pins	A	120117-05-001	CAM12RAM17003

Specifications/技术参数

Number of contacts/芯数	3	4	5	8	12	17
Termination/接线方式	moulded on cable/成型线					
Wire gauge/线规	0.14/0.25/0.34/0.5mm ² / (26/24/22/20 AWG)					
Operating temperature/工作温度	-25°C ~ +80°C					
Mechanical operation/插拔次数	> 100 mating cycles					
Rated voltage/额定电压	250V		60V		30V	
Rated current (40°C)/额定电流	4A			2A		1.5A
Protection degree/防护等级	IP67/IP68					
Contact resistance/接触电阻	< 10mΩ					
Insulation resistance/绝缘电阻	≥100MΩ					
Pin contact/插针材料	CuZn					
Socket contact/插孔材料	CuSn					
Contact plating/针孔镀层材料	Au					

M12 Circular connectors

Female cable (90°)

Product figure



Scale diagram

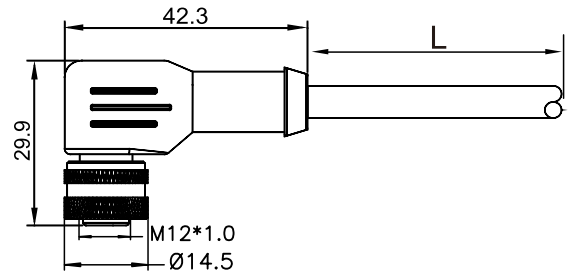

Contact layout/针孔排布 (Front view/前视图)

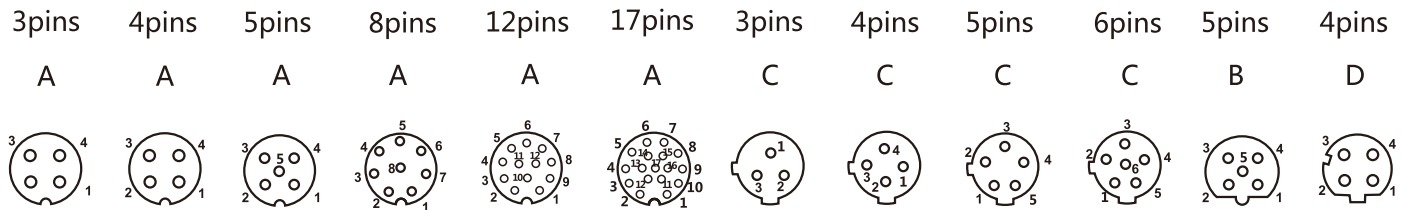

Order Data/订货信息

Contacts/芯数	Coding	Order No/订货号	P/N/料号
3pins	A	120103-06-001	CAM12RAF03003
	C	120303-06-001	CAM12RCF03003
4pins	A	120104-06-001	CAM12RAF04003
	C	120304-06-001	CAM12RCF04003
	D	120404-06-001	CAM12RDF04003
5pins	A	120105-06-001	CAM12RAF05003
	B	120205-06-001	CAM12RBF05003
	C	120305-06-001	CAM12RCF05003
6pins	C	120306-06-001	CAM12RCF06003
8pins	A	120108-06-001	CAM12RAF08003
12pins	A	120112-06-001	CAM12RAF12003
17pins	A	120117-06-001	CAM12RAF17003

Specifications/技术参数

Number of contacts/芯数	3	4	5	8	12	17
Termination/接线方式	moulded on cable/成型线					
Wire gauge/线规	0.14/0.25/0.34/0.5mm ² / (26/24/22/20 AWG)					
Operating temperature/工作温度	-25°C ~ +80°C					
Mechanical operation/插拔次数	> 100 mating cycles					
Rated voltage/额定电压	250V		60V		30V	
Rated current (40°C)/额定电流	4A			2A		1.5A
Protection degree/防护等级	IP67/IP68					
Contact resistance/接触电阻	< 10mΩ					
Insulation resistance/绝缘电阻	≥ 100MΩ					
Pin contact/插针材料	CuZn					
Socket contact/插孔材料	CuSn					
Contact plating/针孔镀层材料	Au					

M12 Circular connectors

Male cable (Y Splitter)

Product figure



Scale diagram

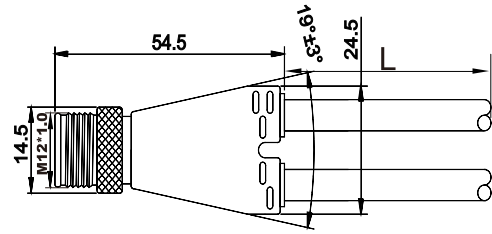

Contact layout/针孔排布 (Front view/前视图)

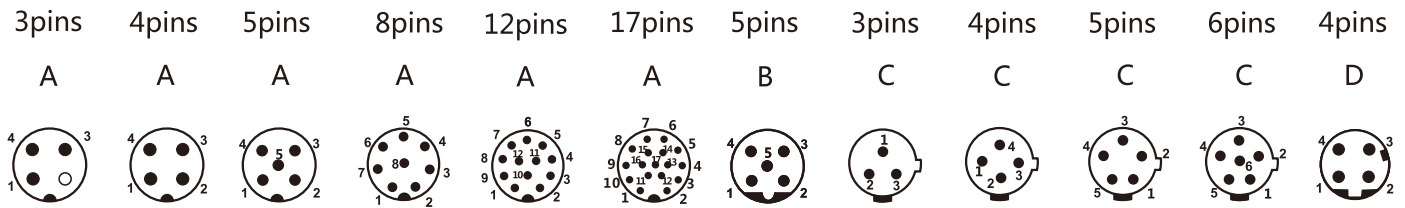

Order Data/订货信息

Contacts/芯数	Coding	Order No/订货号	P/N/料号
3pins	A	120103-30-001	CAM12SAM03004
	C	120303-30-001	CAM12SCM03004
4pins	A	120104-30-001	CAM12SAM04004
	C	120304-30-001	CAM12SCM04004
	D	120404-30-001	CAM12SDM04004
5pins	A	120105-30-001	CAM12SAM05004
	B	120205-30-001	CAM12SBM05004
	C	120305-30-001	CAM12SCM05004
6pins	C	120306-30-001	CAM12SCM06004
8pins	A	120108-30-001	CAM12SAM08004
12pins	A	120112-30-001	CAM12SAM12004
17pins	A	120117-30-001	CAM12SAM17004

Specifications/技术参数

Number of contacts/芯数	3	4	5	8	12	17
Termination/接线方式	moulded on cable/成型线					
Wire gauge/线规	0.14/0.25/0.34/0.5mm ² / (26/24/22/20 AWG)					
Operating temperature/工作温度	-25°C ~ +80°C					
Mechanical operation/插拔次数	> 100 mating cycles					
Rated voltage/额定电压	250V		60V		30V	
Rated current (40°C)/额定电流	4A			2A		1.5A
Protection degree/防护等级	IP67/IP68					
Contact resistance/接触电阻	< 10mΩ					
Insulation resistance/绝缘电阻	≥ 100MΩ					
Pin contact/插针材料	CuZn					
Socket contact/插孔材料	CuSn					
Contact plating/针孔镀层材料	Au					

M12 Circular connectors

Male cable connector assembly

Product figure



Scale diagram

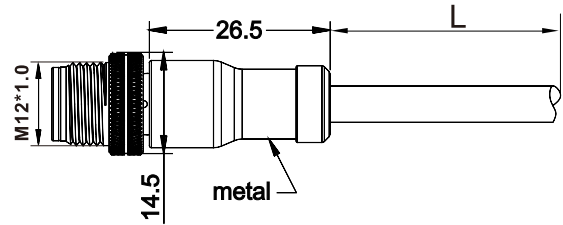

Contact layout/针孔排布 (Front view/前视图)

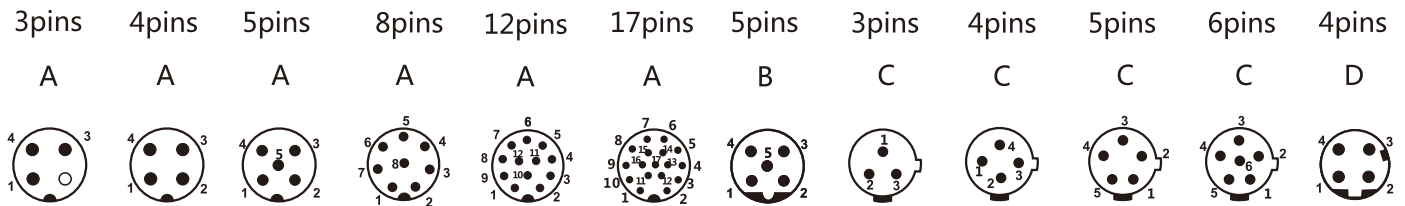

Order Data/订货信息

Contacts/芯数	Coding	Order No/订货号	P/N/料号
3pins	A	120103-05-004	CAM12SAM03005
	C	120303-05-004	CAM12SCM03005
4pins	A	120104-05-005	CAM12SAM04005
	C	120304-05-004	CAM12SCM04005
	D	120404-05-004	CAM12SDM04005
5pins	A	120105-05-004	CAM12SAM05005
	B	120205-05-004	CAM12SBM05005
	C	120305-05-004	CAM12SCM05005
6pins	C	120306-05-004	CAM12SCM06005
8pins	A	120108-05-004	CAM12SAM08005
12pins	A	120112-05-004	CAM12SAM12005
17pins	A	120117-05-004	CAM12SAM17005

Specifications/技术参数

Number of contacts/芯数	3	4	5	8	12	17
Termination/接线方式	moulded on cable/成型线					
Wire gauge/线规	0.14/0.25/0.34/0.5mm ² / (26/24/22/20 AWG)					
Operating temperature/工作温度	-25°C ~ +80°C					
Mechanical operation/插拔次数	> 100 mating cycles					
Rated voltage/额定电压	250V		60V		30V	
Rated current (40°C)/额定电流	4A			2A		1.5A
Protection degree/防护等级	IP67/IP68					
Contact resistance/接触电阻	< 10mΩ					
Insulation resistance/绝缘电阻	≥ 100MΩ					
Pin contact/插针材料	CuZn					
Socket contact/插孔材料	CuSn					
Contact plating/针孔镀层材料	Au					

M12 Circular connectors

Female cable(90° with LED PNP)

Product figure



Scale diagram

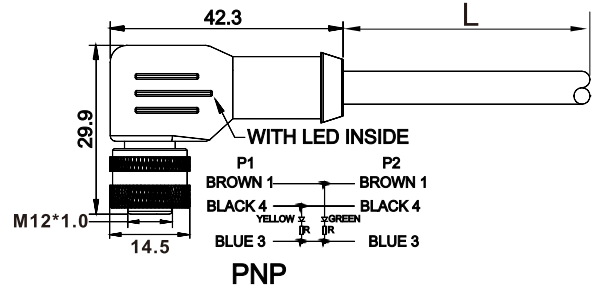

Contact layout/针孔排布 (Front view/前视图)

3pins

4pins

5pins

A

A

A



Order Data/订货信息

Contacts/芯数	Coding	Order No/订货号	P/N/料号
3pins	A	120103-06-002	CAM12RAF03004
4pins	A	120104-06-002	CAM12RAF04004
5pins	A	120105-06-002	CAM12RAF05004

Specifications/技术参数

Number of contacts/芯数	3	4	5
Termination/接线方式	moulded on cable/成型线		
Wire gauge/线规	0.14/0.25/0.34/0.5mm ² / (26/24/22/20 AWG)		
Operating temperature/工作温度	-25°C ~ +80°C		
Mechanical operation/插拔次数	> 100 mating cycles		
Rated voltage/额定电压	250V		60V
Rated current (40°C)/额定电流	4A		
Protection degree/防护等级	IP67/IP68		
Contact resistance/接触电阻	< 10mΩ		
Insulation resistance/绝缘电阻	≥100MΩ		
Pin contact/插针材料	CuZn		
Socket contact/插孔材料	CuSn		
Contact plating/针孔镀层材料	Au		

Female cable(90° with LED NPN)

Product figure



Scale diagram

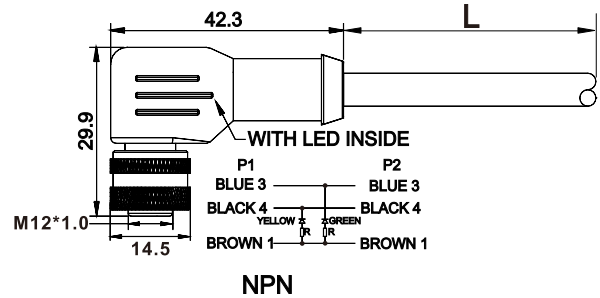

Contact layout/针孔排布 (Front view/前视图)

3pins

4pins

5pins

A

A

A



Order Data/订货信息

Contacts/芯数	Coding	Order No/订货号	P/N/料号
3pins	A	120103-06-003	CAM12RAF03005
4pins	A	120104-06-003	CAM12RAF04005
5pins	A	120105-06-003	CAM12RAF05005

Specifications/技术参数

Number of contacts/芯数	3	4	5
Termination/接线方式	moulded on cable/成型线		
Wire gauge/线规	0.14/0.25/0.34/0.5mm ² / (26/24/22/20 AWG)		
Operating temperature/工作温度	-25°C ~ +80°C		
Mechanical operation/插拔次数	> 100 mating cycles		
Rated voltage/额定电压	250V		60V
Rated current (40°C)/额定电流	4A		
Protection degree/防护等级	IP67/IP68		
Contact resistance/接触电阻	< 10mΩ		
Insulation resistance/绝缘电阻	≥100MΩ		
Pin contact/插针材料	CuZn		
Socket contact/插孔材料	CuSn		
Contact plating/针孔镀层材料	Au		

M12 Circular connectors

Male to RJ45 cable

Product figure



Scale diagram

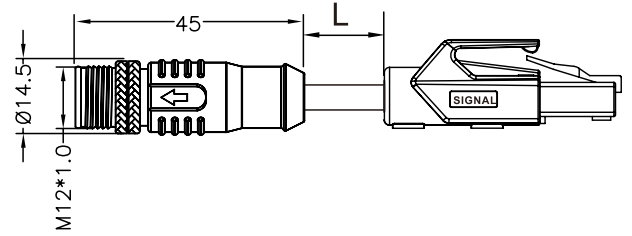

Contact layout/针孔排布 (Front view/前视图)

4pins

RJ45

D



Order Data/订货信息

Contacts/芯数	Coding	Order No/订货号	P/N/料号
4pins	D	120404-57-001	CAM12SDM04001//RJ45

Specifications/技术参数

Number of contacts/芯数	4
Termination/接线方式	moulded on cable/成型线
Wire gauge/线规	0.14/0.25/0.34/0.5mm ² / (26/24/22/20 AWG)
Operating temperature/工作温度	-25°C~+80°C
Mechanical operation/插拔次数	> 100 mating cycles
Rated voltage/额定电压	250V
Rated current (40°C)/额定电流	4A
Protection degree/防护等级	IP67
Contact resistance/接触电阻	< 10mΩ
Insulation resistance/绝缘电阻	≥100MΩ
Pin contact/插针材料	CuZn
Socket contact/插孔材料	CuSn
Contact plating/针孔镀层材料	Au

Female to RJ45 cable

Product figure



Scale diagram

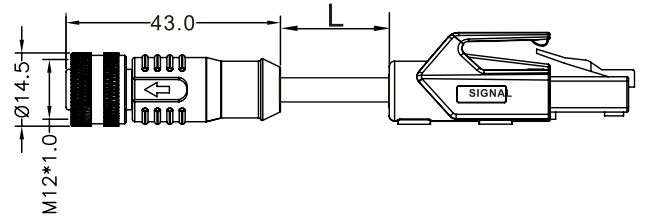

Contact layout/针孔排布 (Front view/前视图)

4pins

RJ45

D



Order Data/订货信息

Contacts/芯数	Coding	Order No/订货号	P/N/料号
4pins	D	120404-67-001	CAM12SDF04001//RJ45

Specifications/技术参数

Number of contacts/芯数	4
Termination/接线方式	moulded on cable/成型线
Wire gauge/线规	0.14/0.25/0.34/0.5mm ² / (26/24/22/20 AWG)
Operating temperature/工作温度	-25°C ~ +80°C
Mechanical operation/插拔次数	> 100 mating cycles
Rated voltage/额定电压	250V
Rated current (40°C)/额定电流	4A
Protection degree/防护等级	IP67
Contact resistance/接触电阻	< 10mΩ
Insulation resistance/绝缘电阻	≥ 100MΩ
Pin contact/插针材料	CuZn
Socket contact/插孔材料	CuSn
Contact plating/针孔镀层材料	Au

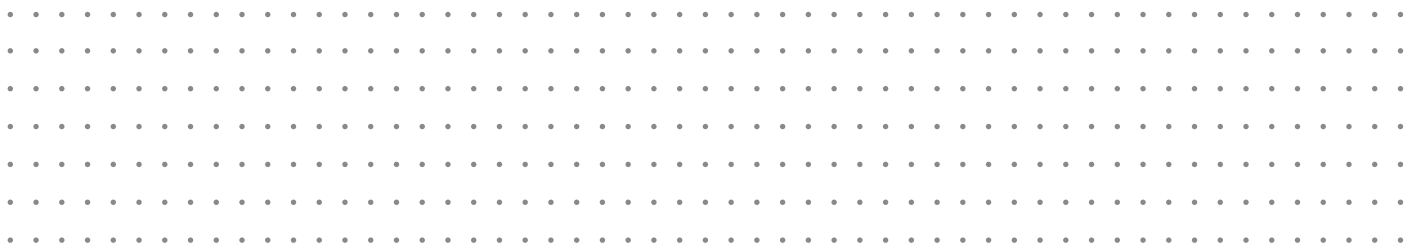

M12 Circular connectors

Male to RJ45 cable

Product figure



Scale diagram

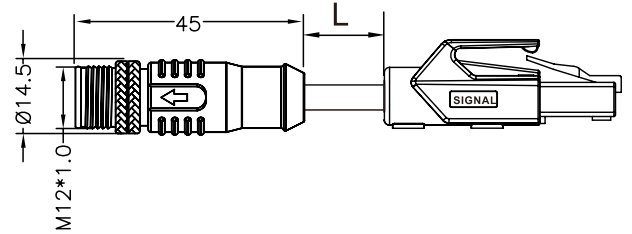

Contact layout/针孔排布 (Front view/前视图)

8pins

RJ45

A



Order Data/订货信息

Contacts/芯数	Coding	Order No/订货号	P/N/料号
8pins	A	120108-57-001	CAM12SAM08002//RJ45

Specifications/技术参数

Number of contacts/芯数	8
Termination/接线方式	moulded on cable/成型线
Wire gauge/线规	0.14/0.25/0.34/0.5mm ² / (26/24/22/20 AWG)
Operating temperature/工作温度	-25°C~+80°C
Mechanical operation/插拔次数	> 100 mating cycles
Rated voltage/额定电压	30V
Rated current (40°C)/额定电流	2A
Protection degree/防护等级	IP67
Contact resistance/接触电阻	< 10mΩ
Insulation resistance/绝缘电阻	≥100MΩ
Pin contact/插针材料	CuZn
Socket contact/插孔材料	CuSn
Contact plating/针孔镀层材料	Au

Female to RJ45 cable

Product figure



Scale diagram

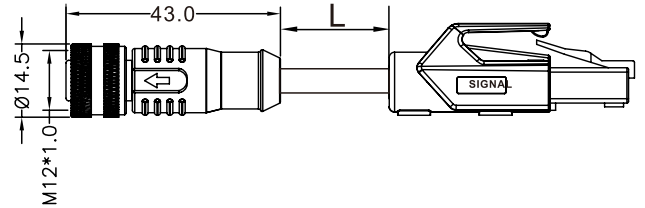

Contact layout/针孔排布 (Front view/前视图)

8pins

RJ45

A



Order Data/订货信息

Contacts/芯数	Coding	Order No/订货号	P/N/料号
8pins	A	120108-67-001	CAM12SAF08002//RJ45

Specifications/技术参数

Number of contacts/芯数	8
Termination/接线方式	moulded on cable/成型线
Wire gauge/线规	0.14/0.25/0.34/0.5mm ² / (26/24/22/20 AWG)
Operating temperature/工作温度	-25°C ~ +80°C
Mechanical operation/插拔次数	> 100 mating cycles
Rated voltage/额定电压	30V
Rated current (40°C)/额定电流	2A
Protection degree/防护等级	IP67
Contact resistance/接触电阻	< 10mΩ
Insulation resistance/绝缘电阻	≥100MΩ
Pin contact/插针材料	CuZn
Socket contact/插孔材料	CuSn
Contact plating/针孔镀层材料	Au

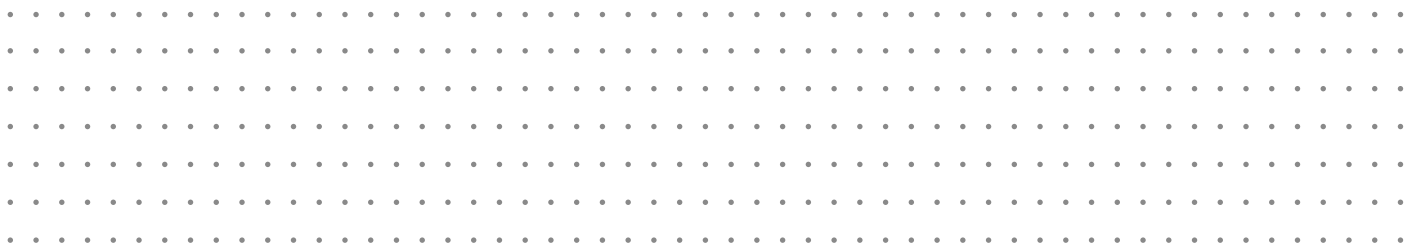

M12 Circular connectors

"Y" Splitter

Product figure (Male to Dual Male)



Scale diagram

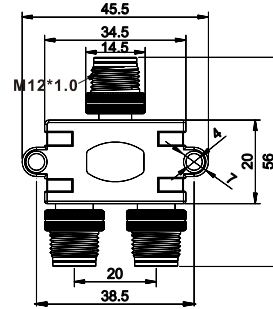

Contact layout/针孔排布 (Front view/前视图)

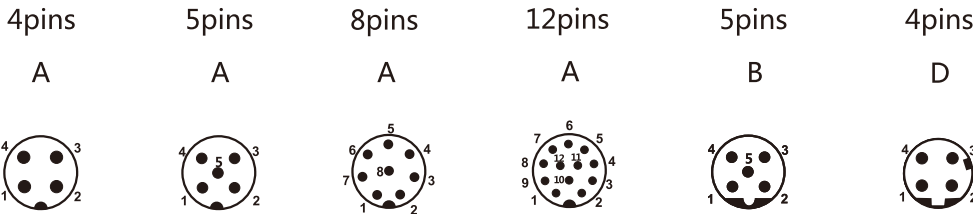

Order Data/订货信息

Contacts/芯数	Coding	Order No/订货号	P/N/料号
4pins	A	120104-10-009	SPM12YA04003
	D	120404-10-008	SPM12YD04001
5pins	A	120105-10-010	SPM12YA05003
	B	120205-10-003	SPM12YB05001
8pins	A	120108-10-012	SPM12YA08003
12pins	A	120112-10-003	SPM12YA12001

Specifications/技术参数

Number of contacts/芯数	4	5	8	12
Termination/接线方式	—			
Wire gauge/线规	—			
Operating temperature/工作温度	-25°C ~ +80°C			
Mechanical operation/插拔次数	> 100 mating cycles			
Rated voltage/额定电压	250V	60V	30V	
Rated current (40°C)/额定电流	4A		2A	1.5A
Protection degree/防护等级	IP67/IP68			
Contact resistance/接触电阻	< 10mΩ			
Insulation resistance/绝缘电阻	≥ 100MΩ			
Pin contact/插针材料	CuZn			
Socket contact/插孔材料	CuSn			
Contact plating/针孔镀层材料	Au			

M12 Circular connectors

"Y" Splitter

Product figure (Female to Dual Female)



Scale diagram

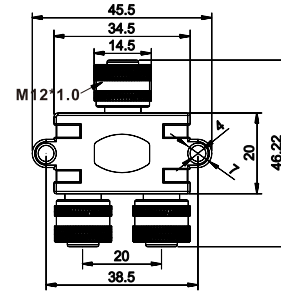

Contact layout/针孔排布 (Front view/前视图)

4pins

5pins

8pins

12pins

5pins

4pins

A

A

A

A

B

D

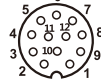
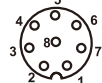

Order Data/订货信息

Contacts/芯数	Coding	Order No/订货号	P/N/料号
4pins	A	120104-10-010	SPM12YA04004
	D	120404-10-009	SPM12YD04002
5pins	A	120105-10-007	SPM12YA05004
	B	120205-10-004	SPM12YB05002
8pins	A	120108-10-013	SPM12YA08004
12pins	A	120112-10-004	SPM12YA12002

Specifications/技术参数

Number of contacts/芯数	4	5	8	12
Termination/接线方式	—			
Wire gauge/线规	—			
Operating temperature/工作温度	-25°C ~ +80°C			
Mechanical operation/插拔次数	> 100 mating cycles			
Rated voltage/额定电压	250V	60V	30V	
Rated current (40°C)/额定电流	4A		2A	1.5A
Protection degree/防护等级	IP67/IP68			
Contact resistance/接触电阻	< 10mΩ			
Insulation resistance/绝缘电阻	≥ 100MΩ			
Pin contact/插针材料	CuZn			
Socket contact/插孔材料	CuSn			
Contact plating/针孔镀层材料	Au			

"Y" Splitter

Product figure (Male to Dual Female)



Scale diagram

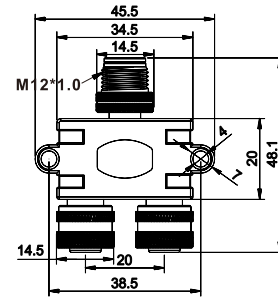

Contact layout/针孔排布 (Front view/前视图)

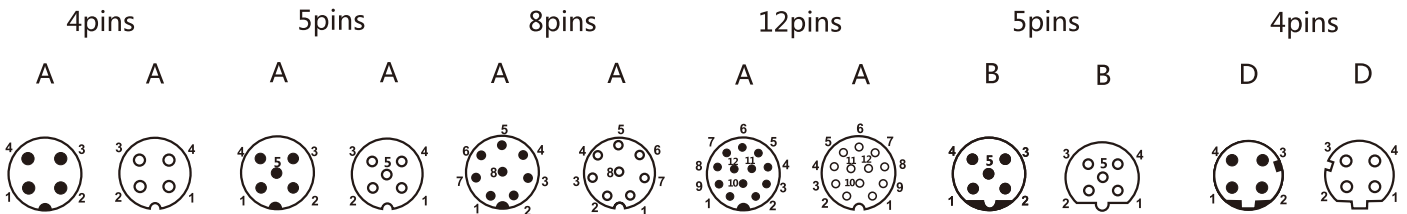

Order Data/订货信息

Contacts/芯数	Coding	Order No/订货号	P/N/料号
4pins	A	120104-10-007	SPM12YA04001
	D	120404-10-010	SPM12YD04003
5pins	A	120105-10-008	SPM12YA05001
	B	120205-10-005	SPM12YB05003
8pins	A	120108-10-010	SPM12YA08001
12pins	A	120112-10-005	SPM12YA12003

Specifications/技术参数

Number of contacts/芯数	4	5	8	12
Termination/接线方式	—			
Wire gauge/线规	—			
Operating temperature/工作温度	-25°C ~ +80°C			
Mechanical operation/插拔次数	> 100 mating cycles			
Rated voltage/额定电压	250V	60V	30V	
Rated current (40°C)/额定电流	4A		2A	1.5A
Protection degree/防护等级	IP67/IP68			
Contact resistance/接触电阻	< 10mΩ			
Insulation resistance/绝缘电阻	≥ 100MΩ			
Pin contact/插针材料	CuZn			
Socket contact/插孔材料	CuSn			
Contact plating/针孔镀层材料	Au			

M12 Circular connectors

"Y" Splitter

Product figure (Female to Male & Female)



Scale diagram

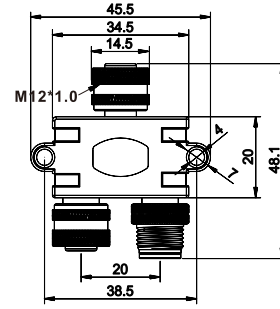

Contact layout/针孔排布 (Front view/前视图)

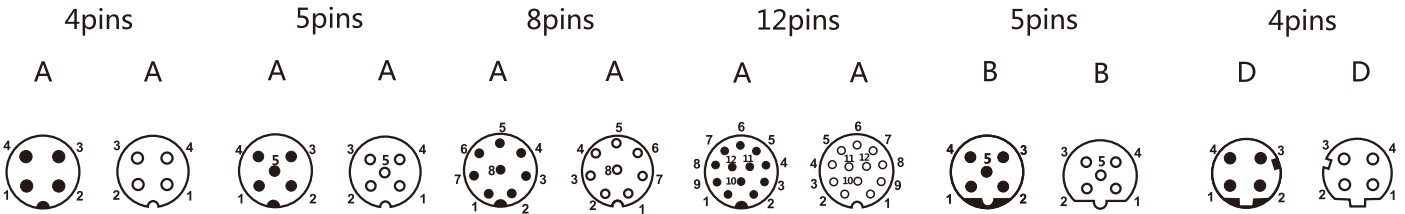

Order Data/订货信息

Contacts/芯数	Coding	Order No/订货号	P/N/料号
4pins	A	120104-10-008	SPM12YA04002
	D	120404-10-011	SPM12YD04004
5pins	A	120105-10-009	SPM12YA05002
	B	120205-10-006	SPM12YB05004
8pins	A	120108-10-011	SPM12YA08002
12pins	A	120112-10-006	SPM12YA12004

Specifications/技术参数

Number of contacts/芯数	4	5	8	12
Termination/接线方式	—			
Wire gauge/线规	—			
Operating temperature/工作温度	-25°C ~ +80°C			
Mechanical operation/插拔次数	> 100 mating cycles			
Rated voltage/额定电压	250V	60V	30V	
Rated current (40°C)/额定电流	4A		2A	1.5A
Protection degree/防护等级	IP67/IP68			
Contact resistance/接触电阻	< 10mΩ			
Insulation resistance/绝缘电阻	≥ 100MΩ			
Pin contact/插针材料	CuZn			
Socket contact/插孔材料	CuSn			
Contact plating/针孔镀层材料	Au			

M12 Circular connectors

"T" Splitter

Product figure (Male to Dual Male)



Scale diagram

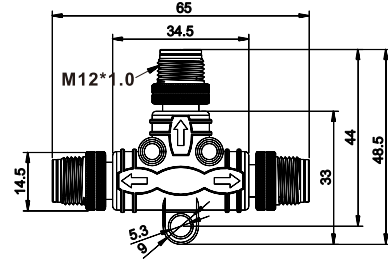

Contact layout/针孔排布 (Front view/前视图)

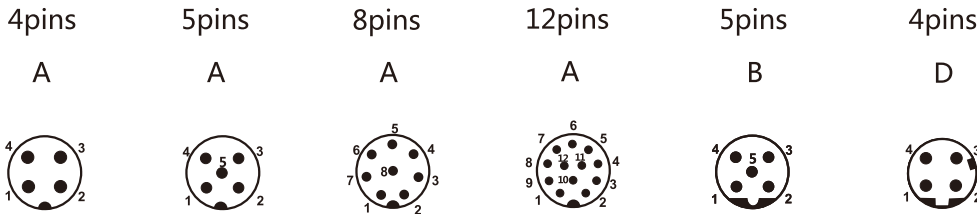

Order Data/订货信息

Contacts/芯数	Coding	Order No/订货号	P/N/料号
4pins	A	120104-10-003	SPM12TA04001
	D	120404-10-012	SPM12TD04001
5pins	A	120105-10-003	SPM12TA05001
	B	120205-10-007	SPM12TB05001
8pins	A	120108-10-005	SPM12TA08001
12pins	A	120112-10-007	SPM12TA12001

Specifications/技术参数

Number of contacts/芯数	4	5	8	12
Termination/接线方式	—			
Wire gauge/线规	—			
Operating temperature/工作温度	-25°C ~ +80°C			
Mechanical operation/插拔次数	> 100 mating cycles			
Rated voltage/额定电压	250V	60V	30V	
Rated current (40°C)/额定电流	4A		2A	1.5A
Protection degree/防护等级	IP67/IP68			
Contact resistance/接触电阻	< 10mΩ			
Insulation resistance/绝缘电阻	≥ 100MΩ			
Pin contact/插针材料	CuZn			
Socket contact/插孔材料	CuSn			
Contact plating/针孔镀层材料	Au			

M12 Circular connectors

"T" Splitter

Product figure (Female to Dual Female)



Scale diagram

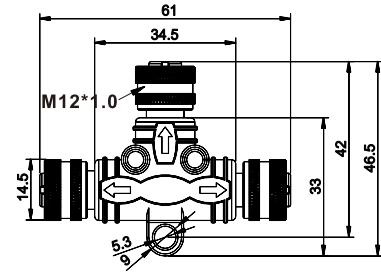

Contact layout/针孔排布 (Front view/前视图)

4pins

A



5pins

A



8pins

A



12pins

A



5pins

B



4pins

D



Order Data/订货信息

Contacts/芯数	Coding	Order No/订货号	P/N/料号
4pins	A	120104-10-004	SPM12TA04002
	D	120404-10-013	SPM12TD04002
5pins	A	120105-10-004	SPM12TA05002
	B	120205-10-008	SPM12TB05002
8pins	A	120108-10-006	SPM12TA08002
12pins	A	120112-10-008	SPM12TA12002

Specifications/技术参数

Number of contacts/芯数	4	5	8	12
Termination/接线方式	—			
Wire gauge/线规	—			
Operating temperature/工作温度	-25°C ~ +80°C			
Mechanical operation/插拔次数	> 100 mating cycles			
Rated voltage/额定电压	250V	60V	30V	
Rated current (40°C)/额定电流	4A		2A	1.5A
Protection degree/防护等级	IP67/IP68			
Contact resistance/接触电阻	< 10mΩ			
Insulation resistance/绝缘电阻	≥ 100MΩ			
Pin contact/插针材料	CuZn			
Socket contact/插孔材料	CuSn			
Contact plating/针孔镀层材料	Au			

M12 Circular connectors

"T" Splitter

Product figure (Female to Male&Female)



Scale diagram

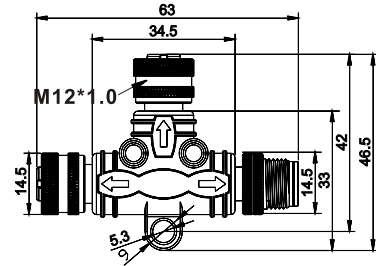

Contact layout/针孔排布 (Front view/前视图)

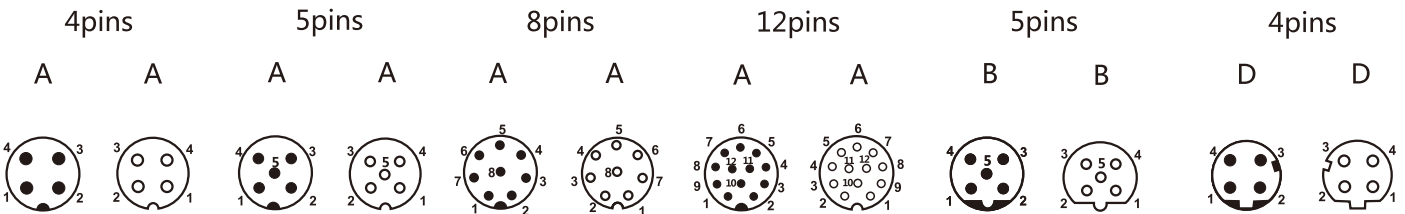

Contacts/芯数	Coding	Order No/订货号	P/N/料号
4pins	A	120104-10-005	SPM12TA04003
	D	120404-10-014	SPM12TD04003
5pins	A	120105-10-005	SPM12TA05003
	B	120205-10-009	SPM12TB05003
8pins	A	120108-10-007	SPM12TA08003
12pins	A	120112-10-009	SPM12TA12003

Specifications/技术参数

Number of contacts/芯数	4	5	8	12
Termination/接线方式	—			
Wire gauge/线规	—			
Operating temperature/工作温度	-25°C ~ +80°C			
Mechanical operation/插拔次数	> 100 mating cycles			
Rated voltage/额定电压	250V	60V	30V	
Rated current (40°C)/额定电流	4A		2A	1.5A
Protection degree/防护等级	IP67/IP68			
Contact resistance/接触电阻	< 10mΩ			
Insulation resistance/绝缘电阻	≥ 100MΩ			
Pin contact/插针材料	CuZn			
Socket contact/插孔材料	CuSn			
Contact plating/针孔镀层材料	Au			

M12 Circular connectors

"T" Splitter

Product figure (Female to Male&Female)



Scale diagram

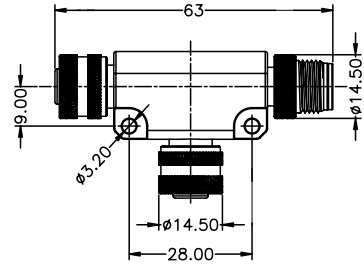

Contact layout/针孔排布 (Front view/前视图)

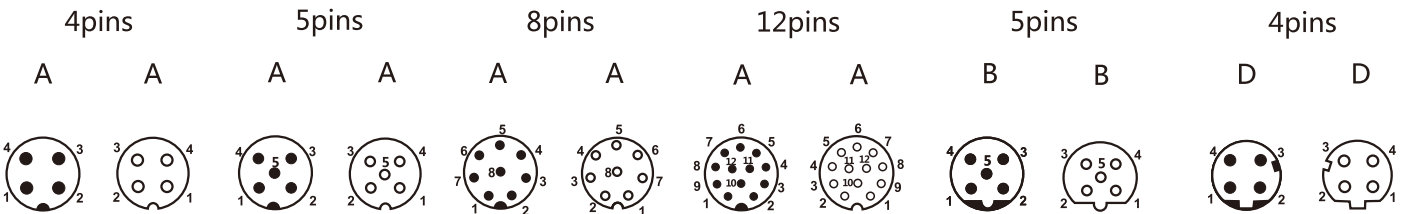

Order Data/订货信息

Contacts/芯数	Coding	Order No/订货号	P/N/料号
4pins	A	120104-10-011	SPM12TA04005
	D	120404-10-015	SPM12TD04004
5pins	A	120105-10-013	SPM12TA05005
	B	120205-10-010	SPM12TB05004
8pins	A	120108-10-013	SPM12TA08005
12pins	A	120112-10-010	SPM12TA12004

Specifications/技术参数

Number of contacts/芯数	4	5	8	12
Termination/接线方式	—			
Wire gauge/线规	—			
Operating temperature/工作温度	-25°C ~ +80°C			
Mechanical operation/插拔次数	> 100 mating cycles			
Rated voltage/额定电压	250V	60V	30V	
Rated current (40°C)/额定电流	4A		2A	1.5A
Protection degree/防护等级	IP67/IP68			
Contact resistance/接触电阻	< 10mΩ			
Insulation resistance/绝缘电阻	≥ 100MΩ			
Pin contact/插针材料	CuZn			
Socket contact/插孔材料	CuSn			
Contact plating/针孔镀层材料	Au			

"Tortoise" Splitter

Product figure (Male to 4 Females)



Scale diagram

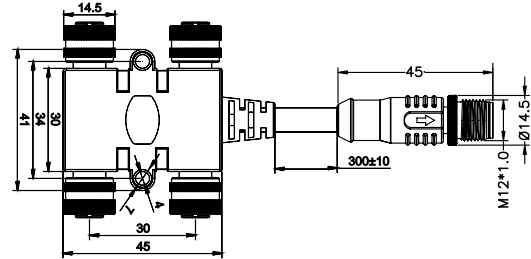

Contact layout/针孔排布 (Front view/前视图)

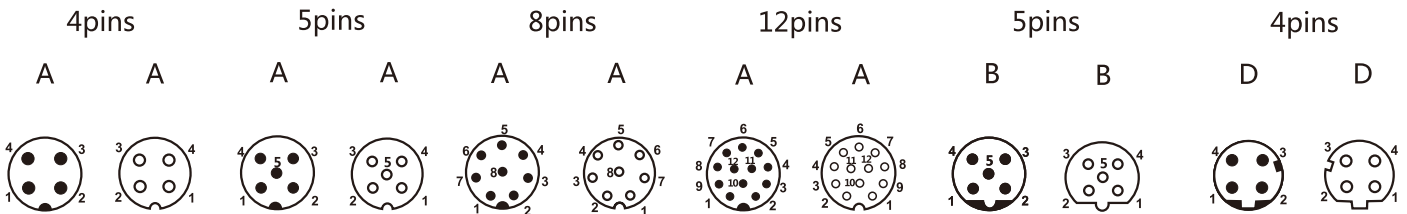

Order Data/订货信息

Contacts/芯数	Coding	Order No/订货号	P/N/料号
4pins	A	120104-10-006	SPM12TA04004
	D	120404-10-016	SPM12TD04005
5pins	A	120105-10-006	SPM12TA05004
	B	120205-10-011	SPM12TB05005
8pins	A	120108-10-008	SPM12TA08004
12pins	A	120112-10-011	SPM12TA12005

Specifications/技术参数

Number of contacts/芯数	4	5	8	12
Termination/接线方式	—			
Wire gauge/线规	—			
Operating temperature/工作温度	-25°C ~ +80°C			
Mechanical operation/插拔次数	> 100 mating cycles			
Rated voltage/额定电压	250V	60V	30V	
Rated current (40°C)/额定电流	4A		2A	1.5A
Protection degree/防护等级	IP67/IP68			
Contact resistance/接触电阻	< 10mΩ			
Insulation resistance/绝缘电阻	≥ 100MΩ			
Pin contact/插针材料	CuZn			
Socket contact/插孔材料	CuSn			
Contact plating/针孔镀层材料	Au			

Adapter

Product figure (Male to Male PG9)



Scale diagram

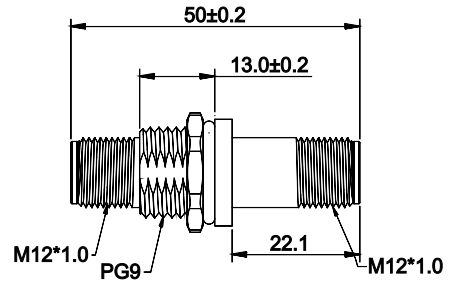

Contact layout/针孔排布 (Front view/前视图)

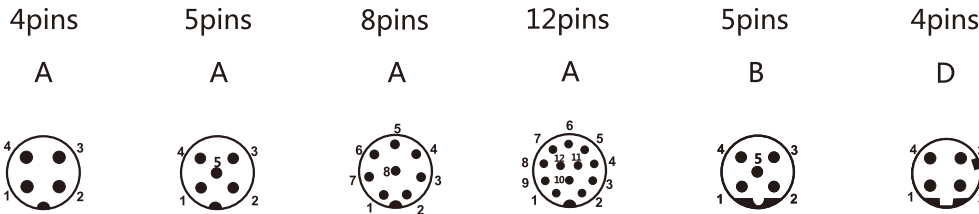

Order Data/订货信息

Contacts/芯数	Coding	Order No/订货号	P/N/料号
4pins	A	120104-10-002	SPM12SA04002
	D	120404-10-002	SPM12SD04002
5pins	A	120105-10-002	SPM12SA05002
	B	120205-10-002	SPM12SB05002
8pins	A	120108-10-002	SPM12SA08002
12pins	A	120112-10-002	SPM12SA12002

Specifications/技术参数

Number of contacts/芯数	4	5	8	12
Termination/接线方式	—			
Wire gauge/线规	—			
Operating temperature/工作温度	-25°C ~ +80°C			
Mechanical operation/插拔次数	> 100 mating cycles			
Rated voltage/额定电压	250V	60V	30V	
Rated current (40°C)/额定电流	4A		2A	1.5A
Protection degree/防护等级	IP67/IP68			
Contact resistance/接触电阻	< 10mΩ			
Insulation resistance/绝缘电阻	≥ 100MΩ			
Pin contact/插针材料	CuZn			
Socket contact/插孔材料	CuSn			
Contact plating/针孔镀层材料	Au			

M12 Circular connectors

Adapter

Product figure (Male to Female PG9 with shield)

Scale diagram

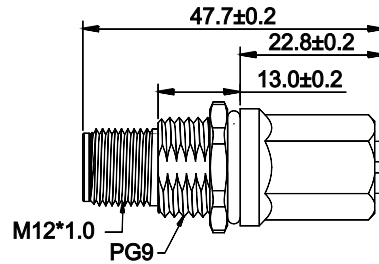

Contact layout/针孔排布 (Front view/前视图)

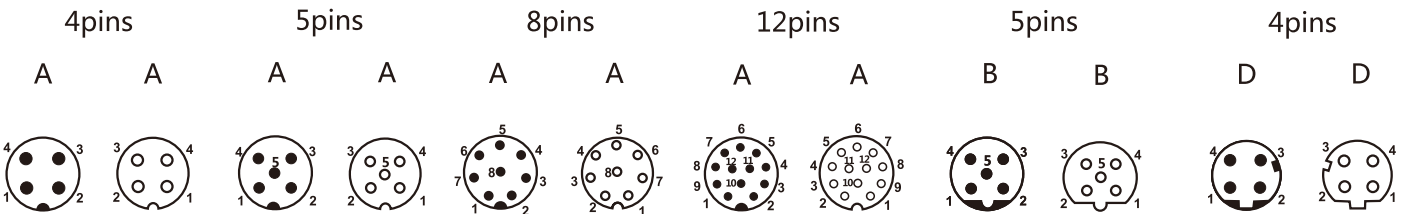

Order Data/订货信息

Contacts/芯数	Coding	Order No/订货号	P/N/料号
4pins	A	120104-10-001	SPM12SA04001
	D	120404-10-001	SPM12SD04001
5pins	A	120105-10-001	SPM12SA05001
	B	120205-10-001	SPM12SB05001
8pins	A	120108-10-001	SPM12SA08001
12pins	A	120112-10-001	SPM12SA12001

Specifications/技术参数

Number of contacts/芯数	4	5	8	12
Termination/接线方式	—			
Wire gauge/线规	—			
Operating temperature/工作温度	-25°C ~ +80°C			
Mechanical operation/插拔次数	> 100 mating cycles			
Rated voltage/额定电压	250V	60V	30V	
Rated current (40°C)/额定电流	4A		2A	1.5A
Protection degree/防护等级	IP67/IP68			
Contact resistance/接触电阻	< 10mΩ			
Insulation resistance/绝缘电阻	≥ 100MΩ			
Pin contact/插针材料	CuZn			
Socket contact/插孔材料	CuSn			
Contact plating/针孔镀层材料	Au			

M12 Male to Rj45 Adapter (90°)

Product figure



Scale diagram

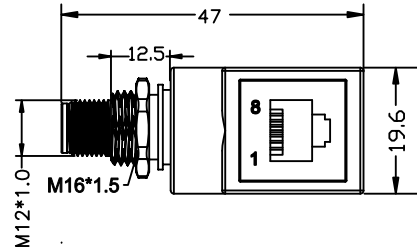

Contact layout/针孔排布 (Front view/前视图)

8pins

4pins

RJ45

A

D



Order Data/订货信息

Contacts/芯数	Coding	Order No/订货号	P/N/料号
4pins	D	120404-10-005	SPM12SD04005
8pins	A	120108-10-015	SPM12SA08005

Specifications/技术参数

Number of contacts/芯数	4	8
Termination/接线方式	—	
Wire gauge/线规	—	
Operating temperature/工作温度	-25°C ~ +85°C	
Mechanical operation/插拔次数	> 100 mating cycles	
Rated voltage/额定电压	250V	30V
Rated current (40°C)/额定电流	4A	2A
Protection degree/防护等级	IP67	
Contact resistance/接触电阻	< 10mΩ	
Insulation resistance/绝缘电阻	≥100MΩ	
Pin contact/插针材料	CuZn	
Socket contact/插孔材料	CuSn	
Contact plating/针孔镀层材料	Au	

M12 Circular connectors

M12 Female to Rj45 Adapter (90°)

Product figure



Scale diagram

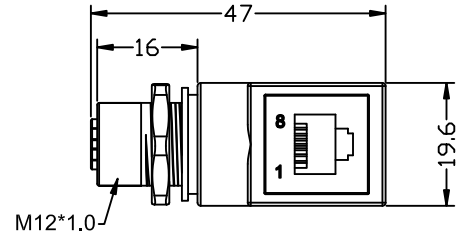

Contact layout/针孔排布 (Front view/前视图)

8pins

4pins

RJ45

A

D



Order Data/订货信息

Contacts/芯数	Coding	Order No/订货号	P/N/料号
4pins	D	120404-10-003	SPM12SD04003
8pins	A	120108-10-003	SPM12SA08003

Specifications/技术参数

Number of contacts/芯数	4	8
Termination/接线方式	—	
Wire gauge/线规	—	
Operating temperature/工作温度	-25°C ~ +85°C	
Mechanical operation/插拔次数	> 100 mating cycles	
Rated voltage/额定电压	250V	30V
Rated current (40°C)/额定电流	4A	2A
Protection degree/防护等级	IP67	
Contact resistance/接触电阻	< 10mΩ	
Insulation resistance/绝缘电阻	≥100MΩ	
Pin contact/插针材料	CuZn	
Socket contact/插孔材料	CuSn	
Contact plating/针孔镀层材料	Au	

M12 Male to Rj45 Adapter (180°)

Product figure



Scale diagram

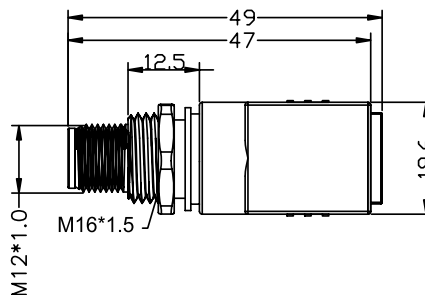

Contact layout/针孔排布 (Front view/前视图)

8pins

4pins

RJ45

A

D



Order Data/订货信息

Contacts/芯数	Coding	Order No/订货号	P/N/料号
4pins	D	120404-10-006	SPM12SD04006
8pins	A	120108-10-014	SPM12SA08006

Specifications/技术参数

Number of contacts/芯数	4	8
Termination/接线方式	—	
Wire gauge/线规	—	
Operating temperature/工作温度	-25°C ~ +85°C	
Mechanical operation/插拔次数	> 100 mating cycles	
Rated voltage/额定电压	250V	30V
Rated current (40°C)/额定电流	4A	2A
Protection degree/防护等级	IP67	
Contact resistance/接触电阻	< 10mΩ	
Insulation resistance/绝缘电阻	≥100MΩ	
Pin contact/插针材料	CuZn	
Socket contact/插孔材料	CuSn	
Contact plating/针孔镀层材料	Au	

M12 Circular connectors

M12 Female to Rj45 Adapter (180°)

Product figure



Scale diagram

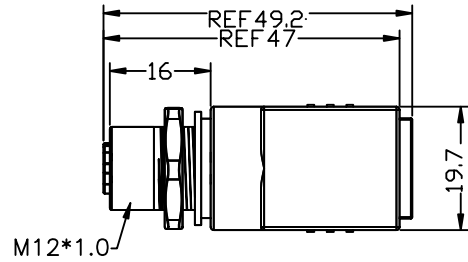

Contact layout/针孔排布 (Front view/前视图)

8pins

4pins

RJ45

A

D



Order Data/订货信息

Contacts/芯数	Coding	Order No/订货号	P/N/料号
4pins	D	120404-10-004	SPM12SD04004
8pins	A	120108-10-004	SPM12SA08004

Specifications/技术参数

Number of contacts/芯数	4	8
Termination/接线方式	—	
Wire gauge/线规	—	
Operating temperature/工作温度	-25°C ~ +85°C	
Mechanical operation/插拔次数	> 100 mating cycles	
Rated voltage/额定电压	250V	30V
Rated current (40°C)/额定电流	4A	2A
Protection degree/防护等级	IP67	
Contact resistance/接触电阻	< 10mΩ	
Insulation resistance/绝缘电阻	≥100MΩ	
Pin contact/插针材料	CuZn	
Socket contact/插孔材料	CuSn	
Contact plating/针孔镀层材料	Au	

M12 Circular connectors

M12 A-coding male SMT

Product figure



Scale diagram

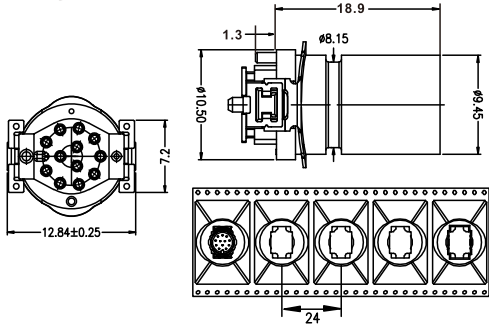

Contact layout/针孔排布 (Front view/前视图)

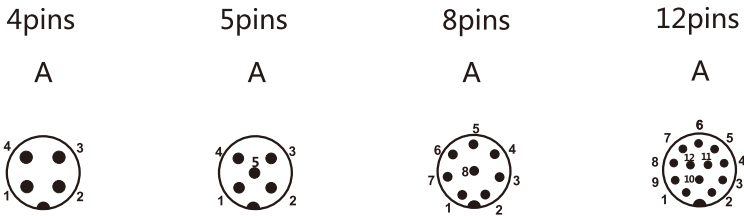

Order Data/订货信息

Contacts/芯数	Coding	Order No/订货号	P/N/料号
4pins	A	120104-03-027	PMM12FAM04018
5pins	A	120105-03-023	PMM12FAM05017
8pins	A	120108-03-034	PMM12FAM08016
12pins	A	120112-03-022	PMM12FAM12017

Specifications/技术参数

Number of contacts/芯数	4	5	8	12
Termination/接线方式	SMT/贴片式			
Wire gauge/线规	—			
Operating temperature/工作温度	-25°C ~ +85°C			
Mechanical operation/插拔次数	> 100 mating cycles			
Rated voltage/额定电压	250V	60V	30V	
Rated current (40°C)/额定电流	4A		2A	1.5A
Protection degree/防护等级	IP67			
Contact resistance/接触电阻	< 10mΩ			
Insulation resistance/绝缘电阻	≥100MΩ			
Pin contact/插针材料	CuZn			
Socket contact/插孔材料	CuSn			
Contact plating/针孔镀层材料	Au			

M12 Circular connectors

M12 A-coding female SMT

Product figure



Scale diagram

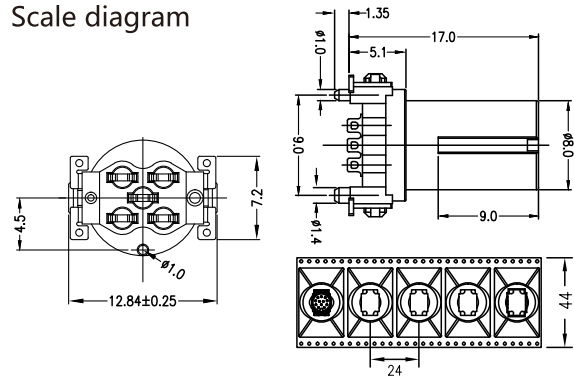

Contact layout/针孔排布 (Front view/前视图)

5pins

8pins

A

A



Order Data/订货信息

Contacts/芯数	Coding	Order No/订货号	P/N/料号
5pins	A	120105-04-023	PMM12FAF05012
8pins	A	120108-04-021	PMM12FAF08013

Specifications/技术参数

Number of contacts/芯数	5	8
Termination/接线方式	SMT/贴片式	
Wire gauge/线规	—	
Operating temperature/工作温度	-25°C ~ +85°C	
Mechanical operation/插拔次数	> 100 mating cycles	
Rated voltage/额定电压	60V	30V
Rated current (40°C)/额定电流	4A	2A
Protection degree/防护等级	IP67	
Contact resistance/接触电阻	< 10mΩ	
Insulation resistance/绝缘电阻	≥ 100MΩ	
Pin contact/插针材料	CuZn	
Socket contact/插孔材料	CuSn	
Contact plating/针孔镀层材料	Au	

M12 A-coding male PCB

Product figure



Scale diagram

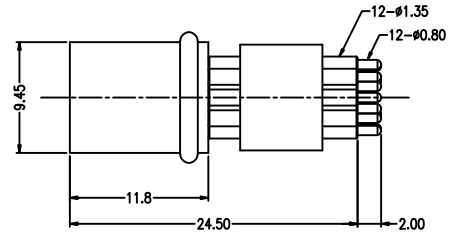

Contact layout/针孔排布 (Front view/前视图)

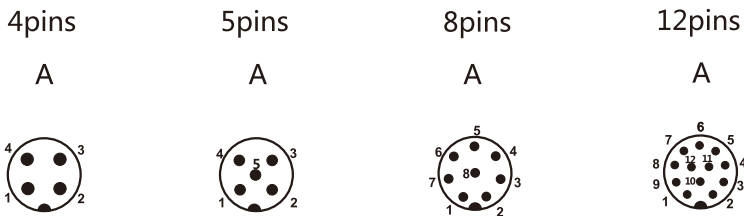

Order Data/订货信息

Contacts/芯数	Coding	Order No/订货号	P/N/料号
4pins	A	120104-03-017	PMM12FAM04017
5pins	A	120105-03-024	PMM12FAM05018
8pins	A	120108-03-027	PMM12FAM08017
12pins	A	120112-03-023	PMM12FAM12018

Specifications/技术参数

Number of contacts/芯数	4	5	8	12
Termination/接线方式	PCB/插板式			
Wire gauge/线规	—			
Operating temperature/工作温度	-25°C ~ +85°C			
Mechanical operation/插拔次数	> 100 mating cycles			
Rated voltage/额定电压	250V	60V	30V	
Rated current (40°C)/额定电流	4A		2A	1.5A
Protection degree/防护等级	IP67			
Contact resistance/接触电阻	< 10mΩ			
Insulation resistance/绝缘电阻	≥100MΩ			
Pin contact/插针材料	CuZn			
Socket contact/插孔材料	CuSn			
Contact plating/针孔镀层材料	Au			

M12 Automation Technology Special X-Coding

- M12 X-coding
- 8 contacts
- Ethernet , Profinet application
- With Cat5/Cat5e/Cat6/Cat7 cables
- 4 twin data transmission up to 10 Gbit/s
- -40°C-85°C temperature range
- 0.5A rated current
- 800V rated impulse voltage
- IP67 degree of protection
- Cable assembly/Panel mount type
Field attachable type/Crimp type are available
- In accordance with DIN IEC 61076-2-109



M12 自动化技术特殊连接器 X型



- M12 X型
- 8 芯
- 以太网应用
- 使用Cat5/Cat5e/Cat6/Cat7 线材
- 4双数据传输10 Gbit / s
- -40°C-85°C 温度范围内
- 0.5A 额定电流
- 800V 额定脉冲电压
- IP67 防护等级
- 电缆组件/面板式
字段可连接类型/压接类型
- 按照DIN IEC 61076-2-109标准

Male assembly connector

Product figure (PG9 with shield)



Scale diagram

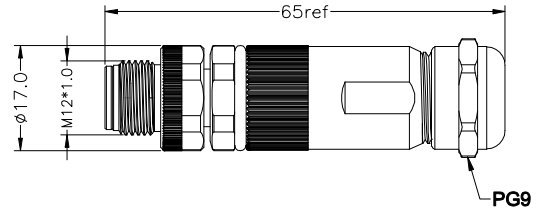

Contact layout/针孔排布 (Front view/前视图)

8pins

X



Order Data/订货信息

Contacts/芯数	Coding	Order No/订货号	P/N/料号
8pins	X	120708-01-001	ASM12XM08001

Specifications/技术参数

Number of contacts/芯数	8
Termination/接线方式	solder/焊接
Wire gauge/线规	0.14/0.25mm ² (26/24AWG)
Cable OD/线材直径	6~8mm
Operating temperature/工作温度	-40°C~+85°C
Mechanical operation/插拔次数	> 100 mating cycles
Rated voltage/额定电压	50V AC / 60V DC
Rated current (40°C)/额定电流	0.5A
Protection degree/防护等级	IP67/IP68
Contact resistance/接触电阻	≤5mΩ
Insulation resistance/绝缘电阻	≥100MΩ
Pin contact/插针材料	CuZn
Socket contact/插孔材料	CuSn
Contact plating/针孔镀层材料	Au

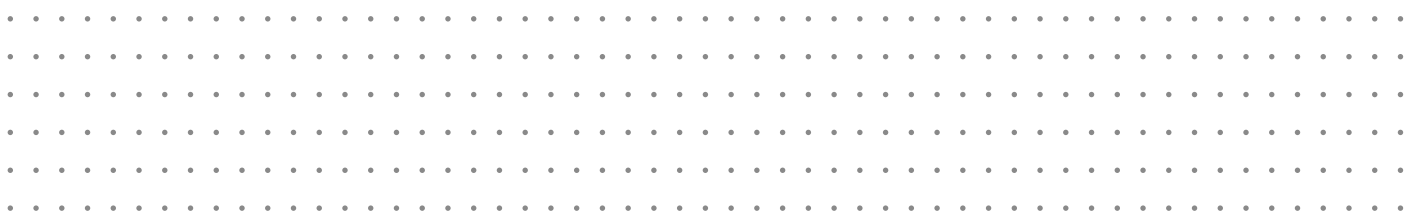

M12 Circular connectors

Female assembly connector

Product figure (PG9 with shield)



Scale diagram

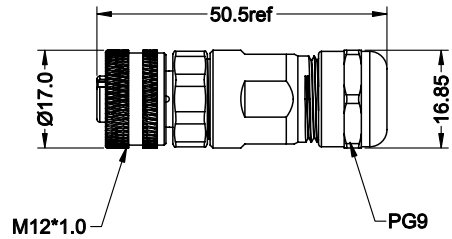

Contact layout/针孔排布 (Front view/前视图)

8pins

X



Order Data/订货信息

Contacts/芯数	Coding	Order No/订货号	P/N/料号
8pins	X	120708-02-001	ASM12XF08001

Specifications/技术参数

Number of contacts/芯数	8
Termination/接线方式	solder/焊接
Wire gauge/线规	0.14/0.25mm ² (26/24 AWG)
Cable OD/线材直径	6~8mm
Operating temperature/工作温度	-40°C ~ +85°C
Mechanical operation/插拔次数	> 100 mating cycles
Rated voltage/额定电压	50V AC / 60V DC
Rated current (40°C)/额定电流	0.5A
Protection degree/防护等级	IP67/IP68
Contact resistance/接触电阻	≤5mΩ
Insulation resistance/绝缘电阻	≥100MΩ
Pin contact/插针材料	CuZn
Socket contact/插孔材料	CuSn
Contact plating/针孔镀层材料	Au

Male assembly connector

Product figure



Scale diagram

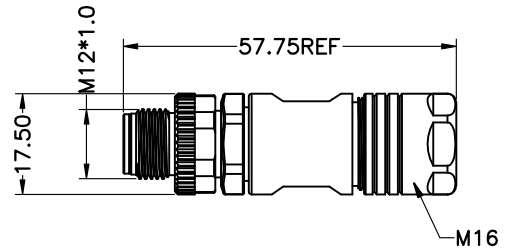

Contact layout/针孔排布 (Front view/前视图)

8pins

X



Order Data/订货信息

Contacts/芯数	Coding	Order No/订货号	P/N/料号
8pins	X	120708-01-002	ASM12XM08002

Specifications/技术参数

Number of contacts/芯数	8
Termination/接线方式	crimp/压接
Wire gauge/线规	0.14/0.25mm ² (26/24 AWG)
Cable OD/线材直径	6~8mm
Operating temperature/工作温度	-40°C ~ +85°C
Mechanical operation/插拔次数	> 100 mating cycles
Rated voltage/额定电压	50V AC / 60V DC
Rated current (40°C)/额定电流	0.5A
Protection degree/防护等级	IP67/IP68
Contact resistance/接触电阻	≤5mΩ
Insulation resistance/绝缘电阻	≥100MΩ
Pin contact/插针材料	CuZn
Socket contact/插孔材料	CuSn
Contact plating/针孔镀层材料	Au

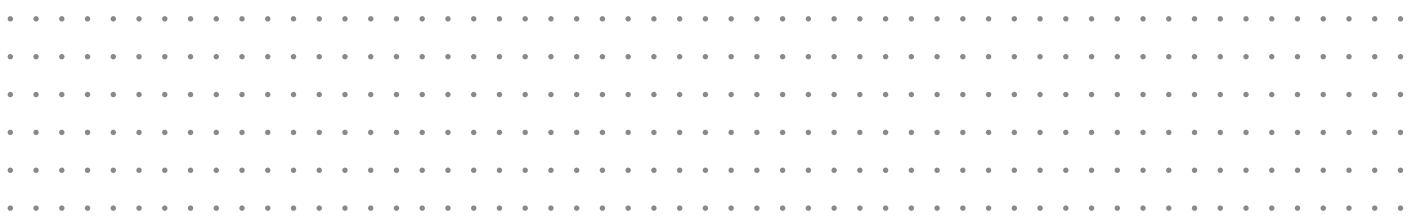

M12 Circular connectors

Female assembly connector

Product figure



Scale diagram

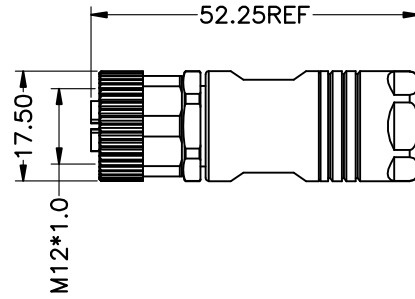

Contact layout/针孔排布 (Front view/前视图)

8pins

X



Order Data/订货信息

Contacts/芯数	Coding	Order No/订货号	P/N/料号
8pins	X	120708-02-002	ASM12XF08002

Specifications/技术参数

Number of contacts/芯数	8
Termination/接线方式	crimp/压接
Wire gauge/线规	0.14/0.25mm ² (26/24 AWG)
Cable OD/线材直径	6~8mm
Operating temperature/工作温度	-40°C~+85°C
Mechanical operation/插拔次数	> 100 mating cycles
Rated voltage/额定电压	50V AC / 60V DC
Rated current (40°C)/额定电流	0.5A
Protection degree/防护等级	IP67/IP68
Contact resistance/接触电阻	≤5mΩ
Insulation resistance/绝缘电阻	≥100MΩ
Pin contact/插针材料	CuZn
Socket contact/插孔材料	CuSn
Contact plating/针孔镀层材料	Au

M12 Circular connectors

Male assembly connector

Product figure



Scale diagram

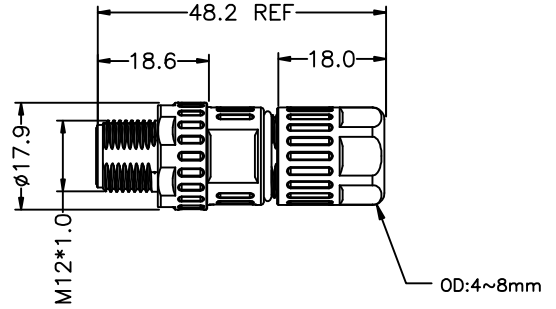

Contact layout/针孔排布 (Front view/前视图)

8pins

X



Order Data/订货信息

Contacts/芯数	Coding	Order No/订货号	P/N/料号
8pins	X	120708-01-007	—

Specifications/技术参数

Number of contacts/芯数	8
Termination/接线方式	crimp/压接
Wire gauge/线规	0.14/0.25mm ² (26/24 AWG)
Cable OD/线材直径	4~8mm
Operating temperature/工作温度	-40°C ~ +85°C
Mechanical operation/插拔次数	> 100 mating cycles
Rated voltage/额定电压	50V AC / 60V DC
Rated current (40°C)/额定电流	0.5A
Protection degree/防护等级	IP67/IP68
Contact resistance/接触电阻	≤5mΩ
Insulation resistance/绝缘电阻	≥100MΩ
Pin contact/插针材料	CuZn
Socket contact/插孔材料	CuSn
Contact plating/针孔镀层材料	Au

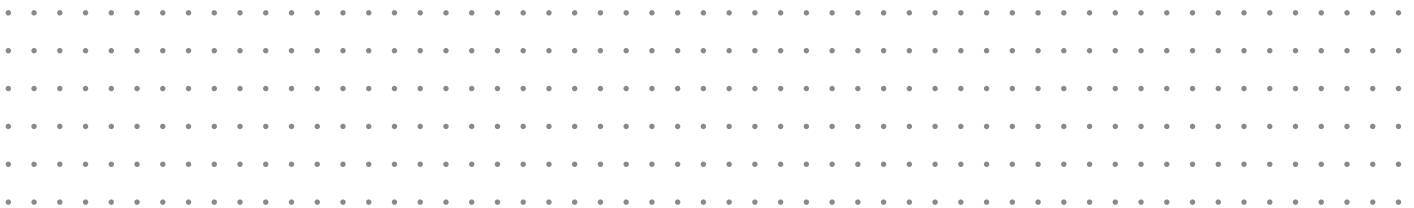

M12 Circular connectors

Male connector for over-molding

Product figure (with shield)



Scale diagram

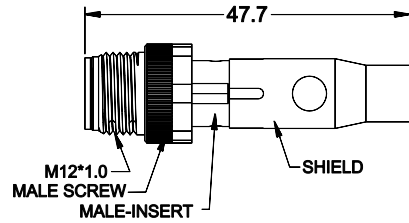

Contact layout/针孔排布 (Front view/前视图)

8pins

X



Order Data/订货信息

Contacts/芯数	Coding	Order No/订货号	P/N/料号
8pins	X	120708-20-001	M12XM08001

Specifications/技术参数

Number of contacts/芯数	8
Termination/接线方式	solder/焊接
Wire gauge/线规	0.14/0.25mm ² (26/24 AWG)
Operating temperature/工作温度	-40°C ~ +85°C
Mechanical operation/插拔次数	> 100 mating cycles
Rated voltage/额定电压	50V AC / 60V DC
Rated current (40°C)/额定电流	0.5A
Protection degree/防护等级	IP67/IP68
Contact resistance/接触电阻	≤5mΩ
Insulation resistance/绝缘电阻	≥100MΩ
Pin contact/插针材料	CuZn
Socket contact/插孔材料	CuSn
Contact plating/针孔镀层材料	Au

Female connector for over-molding

Product figure (with shield)



Scale diagram

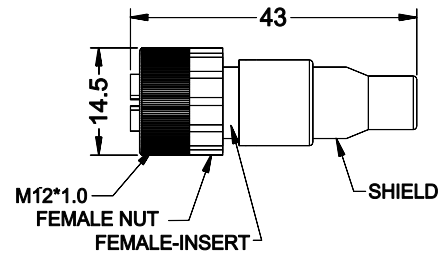

Contact layout/针孔排布 (Front view/前视图)

8pins

X



Order Data/订货信息

Contacts/芯数	Coding	Order No/订货号	P/N/料号
8pins	X	120708-21-001	M12XF08001

Specifications/技术参数

Number of contacts/芯数	8
Termination/接线方式	solder/焊接
Wire gauge/线规	0.14/0.25mm ² (26/24 AWG)
Operating temperature/工作温度	-40°C ~ +85°C
Mechanical operation/插拔次数	> 100 mating cycles
Rated voltage/额定电压	50V AC / 60V DC
Rated current (40°C)/额定电流	0.5A
Protection degree/防护等级	IP67/IP68
Contact resistance/接触电阻	≤5mΩ
Insulation resistance/绝缘电阻	≥100MΩ
Pin contact/插针材料	CuZn
Socket contact/插孔材料	CuSn
Contact plating/针孔镀层材料	Au

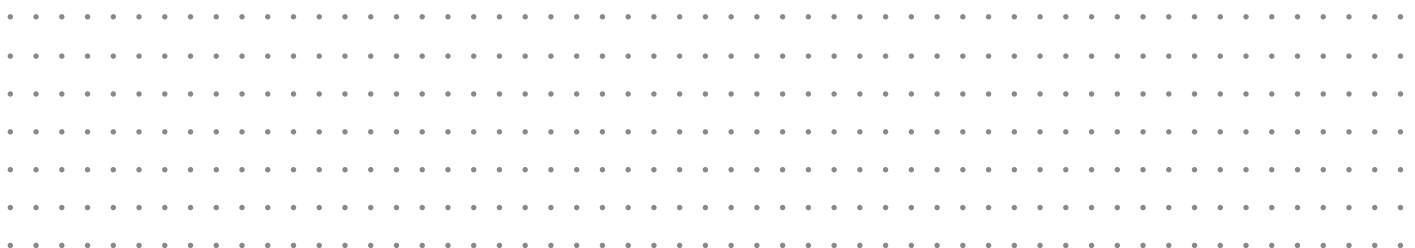

M12 Circular connectors

Male panel connector

Product figure (M16*1.5 front fastened DIP)

Scale diagram

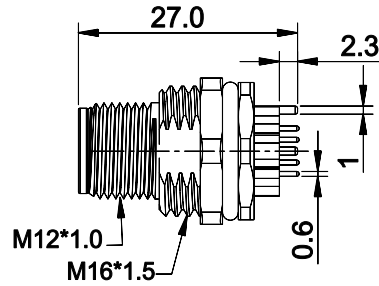

Contact layout/针孔排布 (Front view/前视图)

8pins

X



Order Data/订货信息

Contacts/芯数	Coding	Order No/订货号	P/N/料号
8pins	X	120708-03-001	PMM12FXM08001

Specifications/技术参数

Number of contacts/芯数	8
Termination/接线方式	PCB/插板式
Wire gauge/线规	—
Operating temperature/工作温度	-40°C~+85°C
Mechanical operation/插拔次数	> 100 mating cycles
Rated voltage/额定电压	50V AC / 60V DC
Rated current (40°C)/额定电流	0.5A
Protection degree/防护等级	IP67/IP68
Contact resistance/接触电阻	≤5mΩ
Insulation resistance/绝缘电阻	≥100MΩ
Pin contact/插针材料	CuZn
Socket contact/插孔材料	CuSn
Contact plating/针孔镀层材料	Au

Female panel connector

Product figure (M16*1.5 front fastened DIP)



Scale diagram

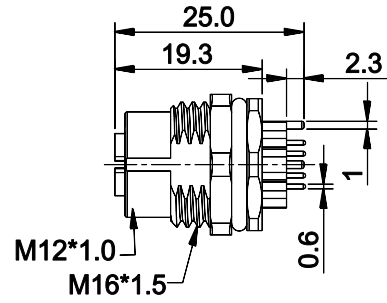

Contact layout/针孔排布 (Front view/前视图)

8pins

X



Order Data/订货信息

Contacts/芯数	Coding	Order No/订货号	P/N/料号
8pins	X	120708-04-001	PMM12FXF08001

Specifications/技术参数

Number of contacts/芯数	8
Termination/接线方式	PCB/插板式
Wire gauge/线规	—
Operating temperature/工作温度	-40°C~+85°C
Mechanical operation/插拔次数	> 100 mating cycles
Rated voltage/额定电压	50V AC / 60V DC
Rated current (40°C)/额定电流	0.5A
Protection degree/防护等级	IP67/IP68
Contact resistance/接触电阻	≤5mΩ
Insulation resistance/绝缘电阻	≥100MΩ
Pin contact/插针材料	CuZn
Socket contact/插孔材料	CuSn
Contact plating/针孔镀层材料	Au

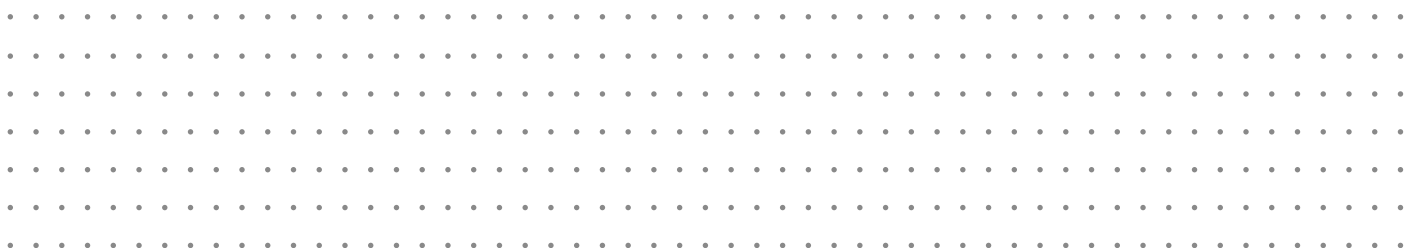

M12 Circular connectors

Female panel connector

Product figure



Scale diagram

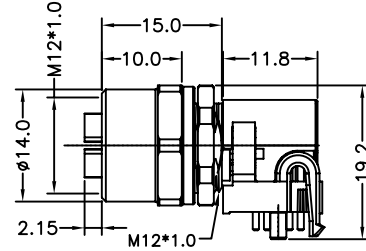

Contact layout/针孔排布 (Front view/前视图)

8pins

X



Order Data/订货信息

Contacts/芯数	Coding	Order No/订货号	P/N/料号
8pins	X	120708-04-049	—

Specifications/技术参数

Number of contacts/芯数	8
Termination/接线方式	PCB/插板式
Wire gauge/线规	—
Operating temperature/工作温度	-40°C~+85°C
Mechanical operation/插拔次数	> 100 mating cycles
Rated voltage/额定电压	50V AC / 60V DC
Rated current (40°C)/额定电流	0.5A
Protection degree/防护等级	IP67/IP68
Contact resistance/接触电阻	≤5mΩ
Insulation resistance/绝缘电阻	≥100MΩ
Pin contact/插针材料	CuZn
Socket contact/插孔材料	CuSn
Contact plating/针孔镀层材料	Au

M12 Circular connectors

Male cable

Product figure



Scale diagram

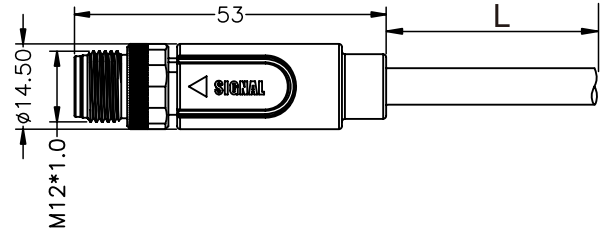

Contact layout/针孔排布 (Front view/前视图)

8pins

X



Order Data/订货信息

Contacts/芯数	Coding	Order No/订货号	P/N/料号
8pins	X	120708-05-002	CAM12SXM08001

Specifications/技术参数

Number of contacts/芯数	8
Termination/接线方式	moulded on cable/成型线
Wire gauge/线规	0.14/0.25mm ² (26/24 AWG)
Operating temperature/工作温度	-40°C ~ +80°C
Mechanical operation/插拔次数	> 100 mating cycles
Rated voltage/额定电压	50V AC / 60V DC
Rated current (40°C)/额定电流	0.5A
Protection degree/防护等级	IP67/IP68
Contact resistance/接触电阻	≤5mΩ
Insulation resistance/绝缘电阻	≥100MΩ
Pin contact/插针材料	CuZn
Socket contact/插孔材料	CuSn
Contact plating/针孔镀层材料	Au

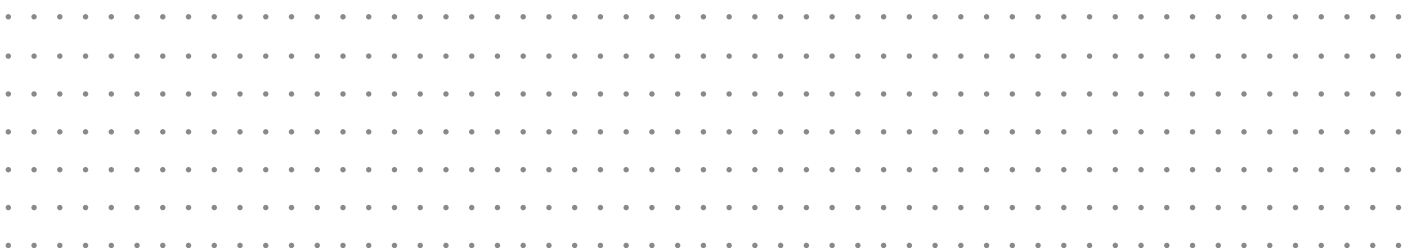

M12 Circular connectors

Female cable

Product figure



Scale diagram

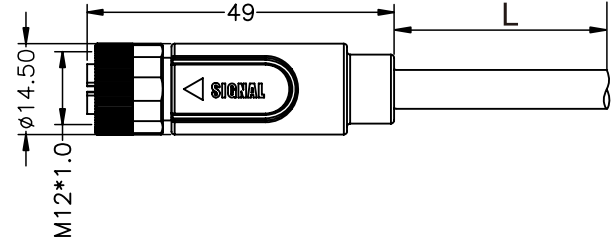

Contact layout/针孔排布 (Front view/前视图)

8pins

X



Order Data/订货信息

Contacts/芯数	Coding	Order No/订货号	P/N/料号
8pins	X	120708-06-001	CAM12SXF08001

Specifications/技术参数

Number of contacts/芯数	8
Termination/接线方式	moulded on cable/成型线
Wire gauge/线规	0.14/0.25mm ² (26/24 AWG)
Operating temperature/工作温度	-40°C~+80°C
Mechanical operation/插拔次数	> 100 mating cycles
Rated voltage/额定电压	50V AC / 60V DC
Rated current (40°C)/额定电流	0.5A
Protection degree/防护等级	IP67/IP68
Contact resistance/接触电阻	≤5mΩ
Insulation resistance/绝缘电阻	≥100MΩ
Pin contact/插针材料	CuZn
Socket contact/插孔材料	CuSn
Contact plating/针孔镀层材料	Au

Male cable

Product figure



Scale diagram

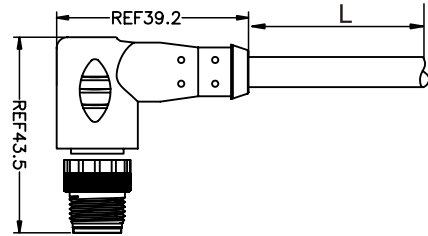

Contact layout/针孔排布 (Front view/前视图)

8pins

X



Order Data/订货信息

Contacts/芯数	Coding	Order No/订货号	P/N/料号
8pins	X	120708-05-003	CAM12RXM08002

Specifications/技术参数

Number of contacts/芯数	8
Termination/接线方式	moulded on cable/成型线
Wire gauge/线规	0.14/0.25mm ² (26/24 AWG)
Operating temperature/工作温度	-40°C ~ +80°C
Mechanical operation/插拔次数	> 100 mating cycles
Rated voltage/额定电压	50V AC / 60V DC
Rated current (40°C)/额定电流	0.5A
Protection degree/防护等级	IP67/IP68
Contact resistance/接触电阻	≤5mΩ
Insulation resistance/绝缘电阻	≥100MΩ
Pin contact/插针材料	CuZn
Socket contact/插孔材料	CuSn
Contact plating/针孔镀层材料	Au

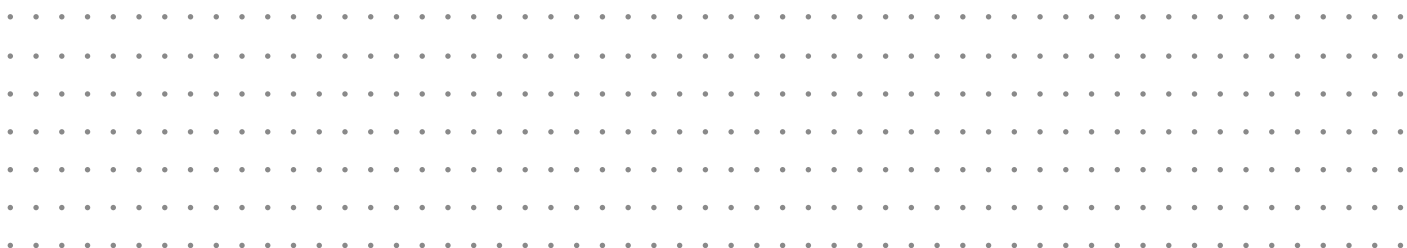

M12 Circular connectors

Male to Male cable

Product figure



Scale diagram

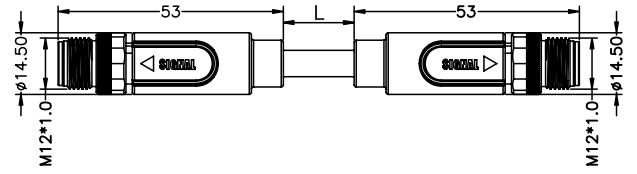

Contact layout/针孔排布 (Front view/前视图)

8pins

X



Order Data/订货信息

Contacts/芯数	Coding	Order No/订货号	P/N/料号
8pins	X	120708-55-001	CAM12SXM08001//CAM12SXM08001

Specifications/技术参数

Number of contacts/芯数	8
Termination/接线方式	moulded on cable/成型线
Wire gauge/线规	0.14/0.25mm ² (26/24 AWG)
Operating temperature/工作温度	-40°C~+80°C
Mechanical operation/插拔次数	> 100 mating cycles
Rated voltage/额定电压	50V AC / 60V DC
Rated current (40°C)/额定电流	0.5A
Protection degree/防护等级	IP67/IP68
Contact resistance/接触电阻	≤5mΩ
Insulation resistance/绝缘电阻	≥100MΩ
Pin contact/插针材料	CuZn
Socket contact/插孔材料	CuSn
Contact plating/针孔镀层材料	Au

Female to Female cable

Product figure



Scale diagram

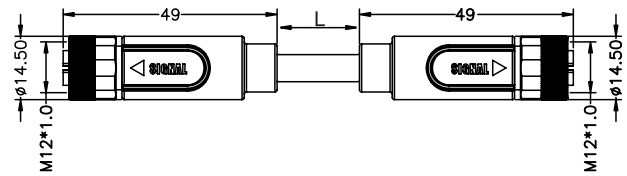

Contact layout/针孔排布 (Front view/前视图)

8pins

X



Order Data/订货信息

Contacts/芯数	Coding	Order No/订货号	P/N/料号
8pins	X	120708-66-001	CAM12SXF08001//CAM12SXF08001

Specifications/技术参数

Number of contacts/芯数	8
Termination/接线方式	moulded on cable/成型线
Wire gauge/线规	0.14/0.25mm ² (26/24 AWG)
Operating temperature/工作温度	-40°C ~ +80°C
Mechanical operation/插拔次数	> 100 mating cycles
Rated voltage/额定电压	50V AC / 60V DC
Rated current (40°C)/额定电流	0.5A
Protection degree/防护等级	IP67/IP68
Contact resistance/接触电阻	≤5mΩ
Insulation resistance/绝缘电阻	≥100MΩ
Pin contact/插针材料	CuZn
Socket contact/插孔材料	CuSn
Contact plating/针孔镀层材料	Au

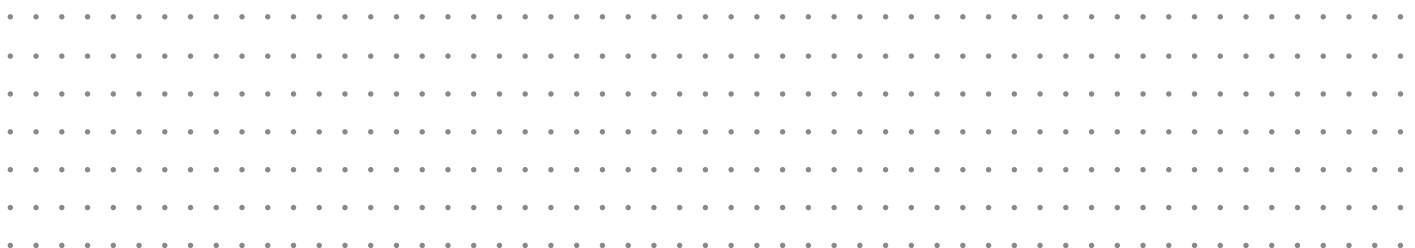

M12 Circular connectors

Male to Female cable

Product figure



Scale diagram

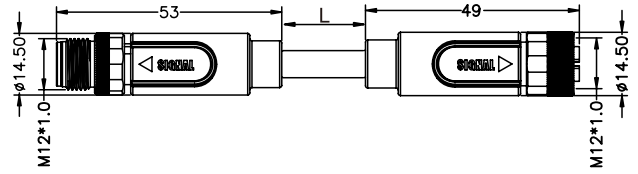

Contact layout/针孔排布 (Front view/前视图)

8pins

X

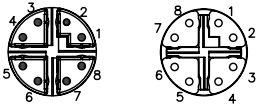

Order Data/订货信息

Contacts/芯数	Coding	Order No/订货号	P/N/料号
8pins	X	120708-56-001	CAM12SXM08001//CAM12SXF08001

Specifications/技术参数

Number of contacts/芯数	8
Termination/接线方式	moulded on cable/成型线
Wire gauge/线规	0.14/0.25mm ² (26/24 AWG)
Operating temperature/工作温度	-40°C~+80°C
Mechanical operation/插拔次数	> 100 mating cycles
Rated voltage/额定电压	50V AC / 60V DC
Rated current (40°C)/额定电流	0.5A
Protection degree/防护等级	IP67/IP68
Contact resistance/接触电阻	≤5mΩ
Insulation resistance/绝缘电阻	≥100MΩ
Pin contact/插针材料	CuZn
Socket contact/插孔材料	CuSn
Contact plating/针孔镀层材料	Au

Male to RJ45 cable

Product figure



Scale diagram

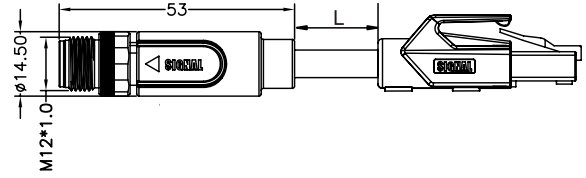

Contact layout/针孔排布 (Front view/前视图)

8pins

RJ45

X

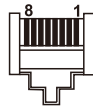

Order Data/订货信息

Contacts/芯数	Coding	Order No/订货号	P/N/料号
8pins	X	120708-57-001	CAM12SXM08001//RJ45

Specifications/技术参数

Number of contacts/芯数	8
Termination/接线方式	moulded on cable/成型线
Wire gauge/线规	0.14/0.25mm ² (26/24 AWG)
Operating temperature/工作温度	-40°C~+80°C
Mechanical operation/插拔次数	> 100 mating cycles
Rated voltage/额定电压	50V AC / 60V DC
Rated current (40°C)/额定电流	0.5A
Protection degree/防护等级	IP67/IP68
Contact resistance/接触电阻	≤5mΩ
Insulation resistance/绝缘电阻	≥100MΩ
Pin contact/插针材料	CuZn
Socket contact/插孔材料	CuSn
Contact plating/针孔镀层材料	Au

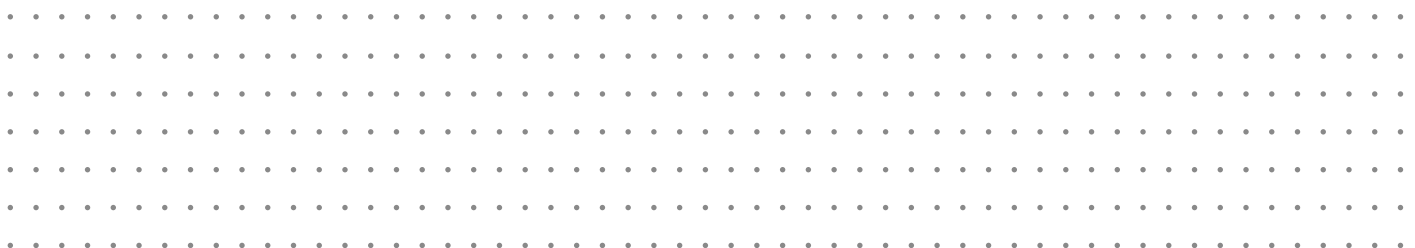

M12 Circular connectors

Female to RJ45 cable

Product figure



Scale diagram

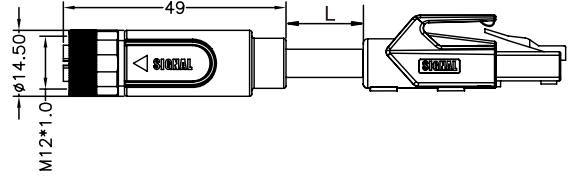

Contact layout/针孔排布 (Front view/前视图)

8pins

RJ45

X

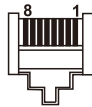

Order Data/订货信息

Contacts/芯数	Coding	Order No/订货号	P/N/料号
8pins	X	120708-67-001	CAM12SXF08001//RJ45

Specifications/技术参数

Number of contacts/芯数	8
Termination/接线方式	moulded on cable/成型线
Wire gauge/线规	0.14/0.25mm ² (26/24 AWG)
Operating temperature/工作温度	-40°C~+80°C
Mechanical operation/插拔次数	> 100 mating cycles
Rated voltage/额定电压	50V AC / 60V DC
Rated current (40°C)/额定电流	0.5A
Protection degree/防护等级	IP67/IP68
Contact resistance/接触电阻	≤5mΩ
Insulation resistance/绝缘电阻	≥100MΩ
Pin contact/插针材料	CuZn
Socket contact/插孔材料	CuSn
Contact plating/针孔镀层材料	Au

M12 Circular connectors

M12 Male to Female Adapter (90°)

Product figure



Scale diagram

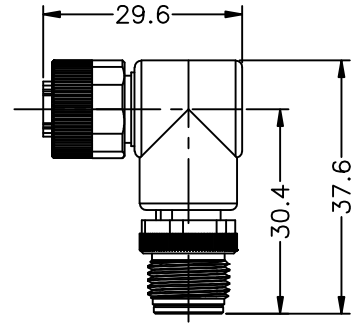

Contact layout/针孔排布 (Front view/前视图)

8pins

X



8pins

X

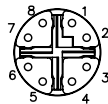

Order Data/订货信息

Contacts/芯数	Coding	Order No/订货号	P/N/料号
8pins	X	120708-10-016	—

Specifications/技术参数

Number of contacts/芯数	8
Termination/接线方式	—
Wire gauge/线规	—
Operating temperature/工作温度	-40°C~+85°C
Mechanical operation/插拔次数	> 100 mating cycles
Rated voltage/额定电压	50V AC / 60V DC
Rated current (40°C)/额定电流	0.5A
Protection degree/防护等级	IP67/IP68
Contact resistance/接触电阻	≤5mΩ
Insulation resistance/绝缘电阻	≥100MΩ
Pin contact/插针材料	CuZn
Socket contact/插孔材料	CuSn
Contact plating/针孔镀层材料	Au

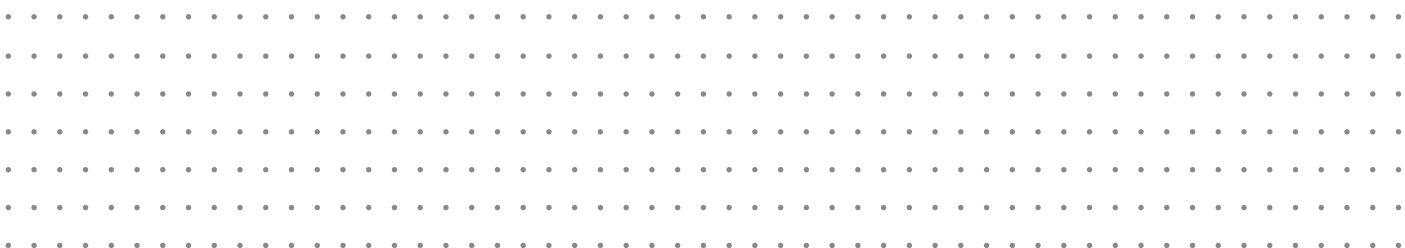

M12 Circular connectors

M12 Male to RJ45 Adapter (90°)

Product figure



Scale diagram

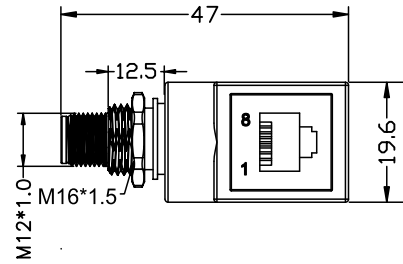

Contact layout/针孔排布 (Front view/前视图)

8pins

RJ45

X



Order Data/订货信息

Contacts/芯数	Coding	Order No/订货号	P/N/料号
8pins	X	120708-10-004	SPM12SX08003

Specifications/技术参数

Number of contacts/芯数	8
Termination/接线方式	—
Wire gauge/线规	—
Operating temperature/工作温度	-40°C~+85°C
Mechanical operation/插拔次数	> 100 mating cycles
Rated voltage/额定电压	50V AC / 60V DC
Rated current (40°C)/额定电流	0.5A
Protection degree/防护等级	IP67/IP68
Contact resistance/接触电阻	≤5mΩ
Insulation resistance/绝缘电阻	≥100MΩ
Pin contact/插针材料	CuZn
Socket contact/插孔材料	CuSn
Contact plating/针孔镀层材料	Au

M12 Female to RJ45 Adapter (90°)

Product figure



Scale diagram

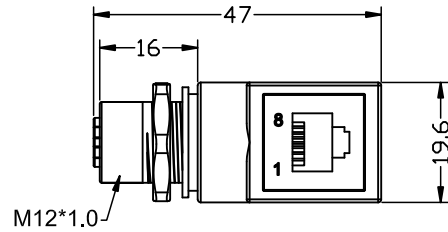

Contact layout/针孔排布 (Front view/前视图)

8pins

RJ45

X



Order Data/订货信息

Contacts/芯数	Coding	Order No/订货号	P/N/料号
8pins	X	120708-10-005	SPM12SX08004

Specifications/技术参数

Number of contacts/芯数	8
Termination/接线方式	—
Wire gauge/线规	—
Operating temperature/工作温度	-40°C~+85°C
Mechanical operation/插拔次数	> 100 mating cycles
Rated voltage/额定电压	50V AC / 60V DC
Rated current (40°C)/额定电流	0.5A
Protection degree/防护等级	IP67/IP68
Contact resistance/接触电阻	≤5mΩ
Insulation resistance/绝缘电阻	≥100MΩ
Pin contact/插针材料	CuZn
Socket contact/插孔材料	CuSn
Contact plating/针孔镀层材料	Au

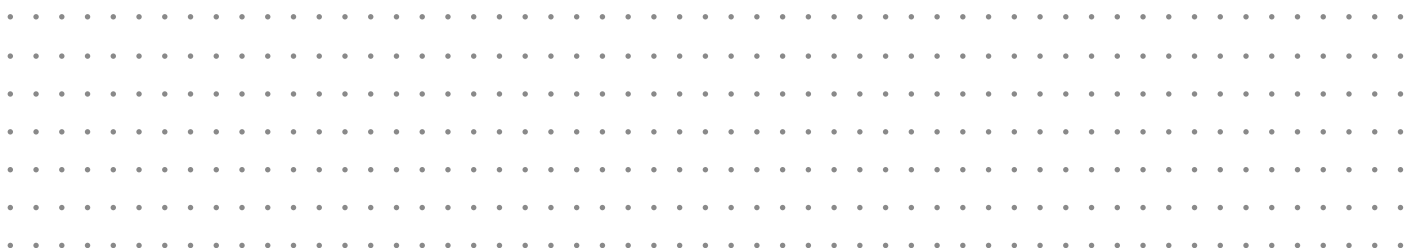

M12 Circular connectors

M12 Male to RJ45 Adapter (180°)

Product figure



Scale diagram

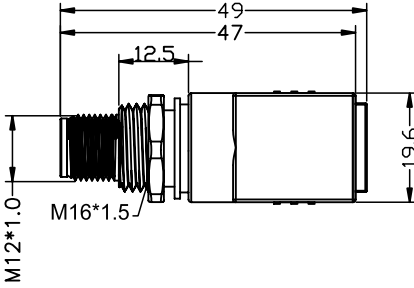

Contact layout/针孔排布 (Front view/前视图)

8pins

RJ45

X



Order Data/订货信息

Contacts/芯数	Coding	Order No/订货号	P/N/料号
8pins	X	120708-10-006	120708-10-006

Specifications/技术参数

Number of contacts/芯数	8
Termination/接线方式	—
Wire gauge/线规	—
Operating temperature/工作温度	-40°C~+85°C
Mechanical operation/插拔次数	> 100 mating cycles
Rated voltage/额定电压	50V AC / 60V DC
Rated current (40°C)/额定电流	0.5A
Protection degree/防护等级	IP67/IP68
Contact resistance/接触电阻	≤5mΩ
Insulation resistance/绝缘电阻	≥100MΩ
Pin contact/插针材料	CuZn
Socket contact/插孔材料	CuSn
Contact plating/针孔镀层材料	Au

M5
M8
M9
M12
M16
M23
7/8
DB
NMEA
D-Sub
USB
RF
P-P

M12 Female to RJ45 Adapter (180°)

Product figure



Scale diagram

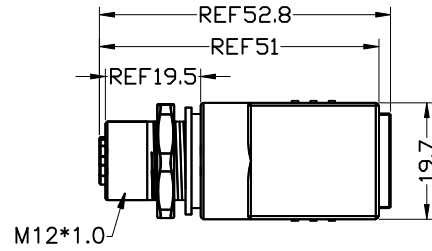

Contact layout/针孔排布 (Front view/前视图)

8pins

RJ45

X



Order Data/订货信息

Contacts/芯数	Coding	Order No/订货号	P/N/料号
8pins	X	120708-10-007	SPM12SX08006

Specifications/技术参数

Number of contacts/芯数	8
Termination/接线方式	—
Wire gauge/线规	—
Operating temperature/工作温度	-40°C~+85°C
Mechanical operation/插拔次数	> 100 mating cycles
Rated voltage/额定电压	50V AC / 60V DC
Rated current (40°C)/额定电流	0.5A
Protection degree/防护等级	IP67/IP68
Contact resistance/接触电阻	≤5mΩ
Insulation resistance/绝缘电阻	≥100MΩ
Pin contact/插针材料	CuZn
Socket contact/插孔材料	CuSn
Contact plating/针孔镀层材料	Au

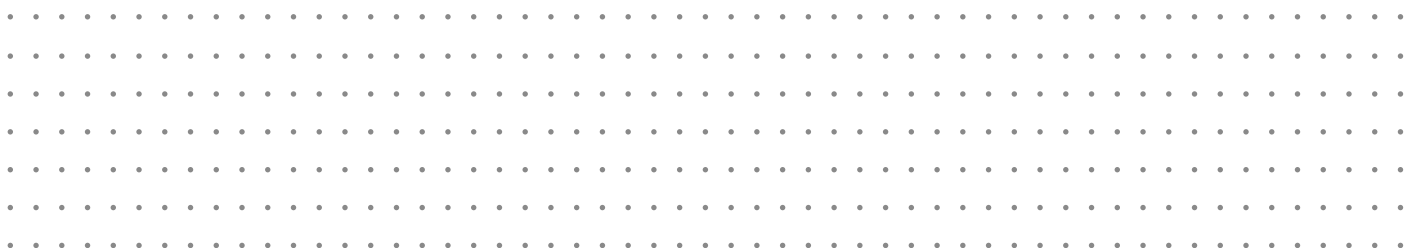

M12 Circular connectors

M12 X-coding female SMT

Product figure



Scale diagram

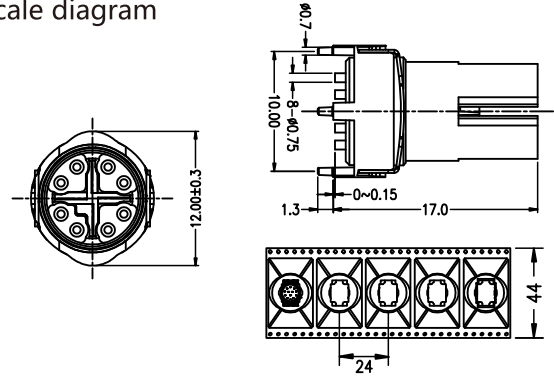

Contact layout/针孔排布 (Front view/前视图)

8pins

X



Order Data/订货信息

Contacts/芯数	Coding	Order No/订货号	P/N/料号
8pins	X	120708-04-005/014	PMM12FXF08003

Specifications/技术参数

Number of contacts/芯数	8
Termination/接线方式	SMT
Wire gauge/线规	—
Operating temperature/工作温度	-40°C~+85°C
Mechanical operation/插拔次数	> 100 mating cycles
Rated voltage/额定电压	50V AC / 60V DC
Rated current (40°C)/额定电流	0.5A
Protection degree/防护等级	IP67
Contact resistance/接触电阻	≤5mΩ
Insulation resistance/绝缘电阻	≥100MΩ
Pin contact/插针材料	CuZn
Socket contact/插孔材料	CuSn
Contact plating/针孔镀层材料	Au

M12 Automation Technology Special S-Coding

- M12 S-coding
- 3/4 contacts
- Max 16AWG/1.5mm² wire gauge
- -40°C-85°C temperature range
- 16A/12A rated current
- 630V rated voltage
- IP67 degree of protection
- Cable assembly/Panel mount type
Field attachable type are available
- In accordance with DIN EN 61076-2-111



M12 自动化技术特殊连接器 S型



- M12 S型
- 3/4 芯
- 最大16AWG/1.5mm²线规
- -40°C-85°C温度范围内
- 16A/12A额定电流
- 630V额定电压
- IP67防护等级
- 电缆组件/面板式/字段可连接类型
- 按照DIN EN 61076-2-111标准

M12 Circular connectors

Male assembly connector

Product figure



Scale diagram

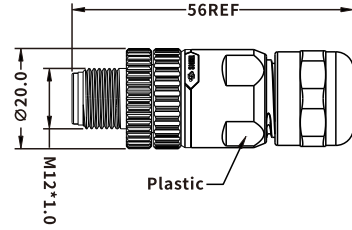

Contact layout/针孔排布 (Front view/前视图)

2+PE

S



3+PE

S



Order Data/订货信息

Contacts/芯数	Coding	Order No/订货号	P/N/料号
2+PE	S	120503-01-001	ASM12SM03001
3+PE	S	120504-01-001	ASM12SM04001

Specifications/技术参数

Number of contacts/芯数	2+PE	3+PE
Termination/接线方式	solder/焊接	
Wire gauge/线规	max. 1.5mm ² (max.16 AWG)	
Cable OD/线材直径	6~8mm	
Operating temperature/工作温度	-40°C~+85°C	
Mechanical operation/插拔次数	> 100 mating cycles	
Rated voltage/额定电压	630V	
Rated current (40°C)/额定电流	12A	
Protection degree/防护等级	IP67/IP68	
Contact resistance/接触电阻	≤3mΩ	
Insulation resistance/绝缘电阻	≥100MΩ	
Pin contact/插针材料	CuZn	
Socket contact/插孔材料	CuSn	
Contact plating/针孔镀层材料	Au	

Female assembly connector

Product figure



Scale diagram

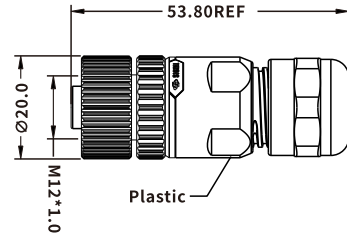

Contact layout/针孔排布 (Front view/前视图)

2+PE

S



3+PE

S



Order Data/订货信息

Contacts/芯数	Coding	Order No/订货号	P/N/料号
2+PE	S	120503-02-001	ASM12SF03001
3+PE	S	120504-02-001	ASM12SF04001

Specifications/技术参数

Number of contacts/芯数	2+PE	3+PE
Termination/接线方式	solder/焊接	
Wire gauge/线规	max. 1.5mm ² (max.16 AWG)	
Cable OD/线材直径	6~8mm	
Operating temperature/工作温度	-40°C~+85°C	
Mechanical operation/插拔次数	> 100 mating cycles	
Rated voltage/额定电压	630V	
Rated current (40°C)/额定电流	12A	
Protection degree/防护等级	IP67/IP68	
Contact resistance/接触电阻	≤3mΩ	
Insulation resistance/绝缘电阻	≥100MΩ	
Pin contact/插针材料	CuZn	
Socket contact/插孔材料	CuSn	
Contact plating/针孔镀层材料	Au	

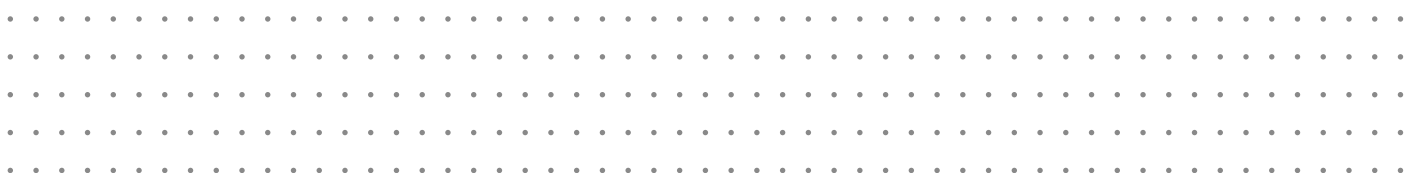

M12 Circular connectors

Female assembly connector

Product figure



Scale diagram

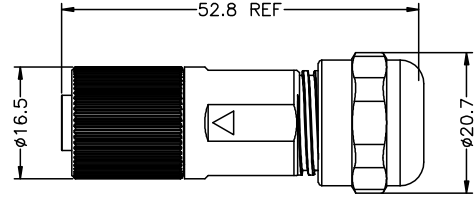

Contact layout/针孔排布 (Front view/前视图)

3+PE

S



Order Data/订货信息

Contacts/芯数	Coding	Order No/订货号	P/N/料号
3+PE	S	120504-02-002	—

Specifications/技术参数

Number of contacts/芯数	3+PE
Termination/接线方式	crimp/压接
Wire gauge/线规	max. 1.5mm ² (max.16 AWG)
Cable OD/线材直径	6~8mm
Operating temperature/工作温度	-40°C~+85°C
Mechanical operation/插拔次数	> 100 mating cycles
Rated voltage/额定电压	630V
Rated current (40°C)/额定电流	12A
Protection degree/防护等级	IP67/IP68
Contact resistance/接触电阻	≤3mΩ
Insulation resistance/绝缘电阻	≥100MΩ
Pin contact/插针材料	CuZn
Socket contact/插孔材料	CuSn
Contact plating/针孔镀层材料	Au

Male panel connector

Product figure (rear fastened)



Scale diagram

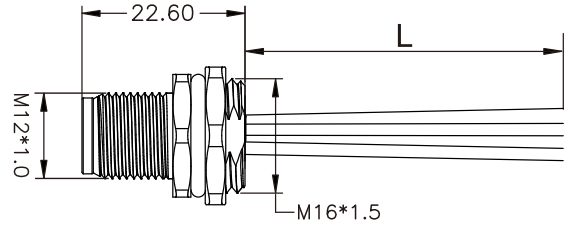

Contact layout/针孔排布 (Front view/前视图)

2+PE

S



3+PE

S



Order Data/订货信息

Contacts/芯数	Coding	Order No/订货号	P/N/料号
2+PE	S	120503-03-001	PMM12BSM03001
3+PE	S	120504-03-001	PMM12BSM04001

Specifications/技术参数

Number of contacts/芯数	2+PE	3+PE
Termination/接线方式	solder/焊线式	
Wire gauge/线规	max. 1.5mm ² (max.16 AWG)	
Operating temperature/工作温度	-40°C~+80°C	
Mechanical operation/插拔次数	> 100 mating cycles	
Rated voltage/额定电压	630V	
Rated current (40°C)/额定电流	12A	
Protection degree/防护等级	IP67/IP68	
Contact resistance/接触电阻	≤3mΩ	
Insulation resistance/绝缘电阻	≥100MΩ	
Pin contact/插针材料	CuZn	
Socket contact/插孔材料	CuSn	
Contact plating/针孔镀层材料	Au	

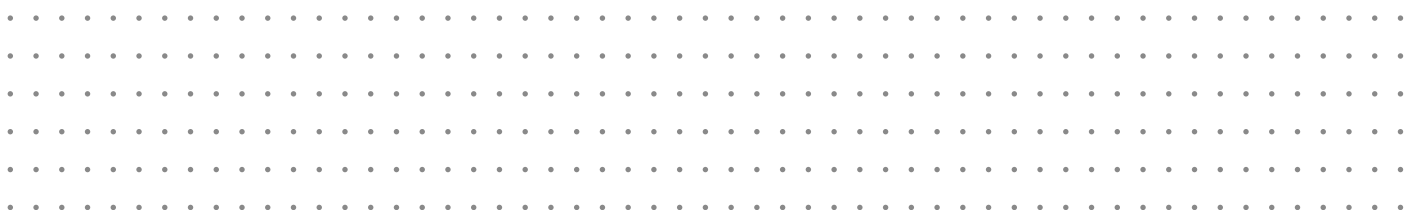

M12 Circular connectors

Female panel connector

Product figure (rear fastened)



Scale diagram

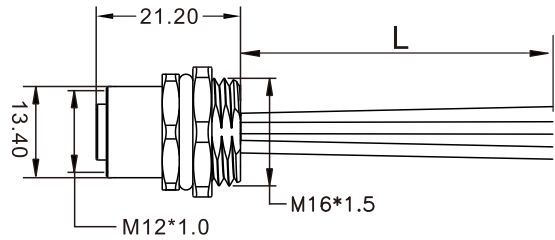

Contact layout/针孔排布 (Front view/前视图)

2+PE

S



3+PE

S



Order Data/订货信息

Contacts/芯数	Coding	Order No/订货号	P/N/料号
2+PE	S	120503-04-001	PMM12BSF03001
3+PE	S	120504-04-002	PMM12BSF04001

Specifications/技术参数

Number of contacts/芯数	2+PE	3+PE
Termination/接线方式	solder/焊线式	
Wire gauge/线规	max. 1.5mm ² (max.16 AWG)	
Operating temperature/工作温度	-40°C ~ +80°C	
Mechanical operation/插拔次数	> 100 mating cycles	
Rated voltage/额定电压	630V	
Rated current (40°C)/额定电流	12A	
Protection degree/防护等级	IP67/IP68	
Contact resistance/接触电阻	≤3mΩ	
Insulation resistance/绝缘电阻	≥100MΩ	
Pin contact/插针材料	CuZn	
Socket contact/插孔材料	CuSn	
Contact plating/针孔镀层材料	Au	

Male cable

Product figure



Scale diagram

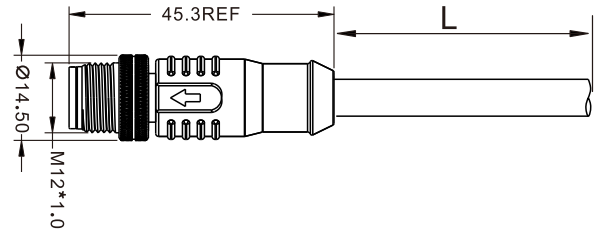

Contact layout/针孔排布 (Front view/前视图)

2+PE

S



3+PE

S



Order Data/订货信息

Contacts/芯数	Coding	Order No/订货号	P/N/料号
2+PE	S	120503-05-001	CAM12SSM03001
3+PE	S	120504-05-002	CAM12SSM04001

Specifications/技术参数

Number of contacts/芯数	2+PE	3+PE
Termination/接线方式	moulded on cable/成型线	
Wire gauge/线规	max. 1.5mm ² (max.16 AWG)	
Operating temperature/工作温度	-40°C ~ +80°C	
Mechanical operation/插拔次数	> 100 mating cycles	
Rated voltage/额定电压	630V	
Rated current (40°C)/额定电流	12A	
Protection degree/防护等级	IP67/IP68	
Contact resistance/接触电阻	≤3mΩ	
Insulation resistance/绝缘电阻	≥100MΩ	
Pin contact/插针材料	CuZn	
Socket contact/插孔材料	CuSn	
Contact plating/针孔镀层材料	Au	



M12 Circular connectors

Female cable

Product figure



Scale diagram

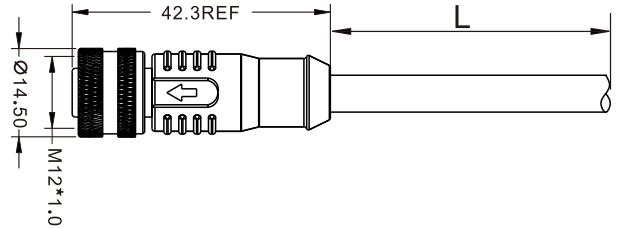

Contact layout/针孔排布 (Front view/前视图)

2+PE

S



3+PE

S



Order Data/订货信息

Contacts/芯数	Coding	Order No/订货号	P/N/料号
2+PE	S	120503-06-001	CAM12SSF03001
3+PE	S	120504-06-002	CAM12SSF04001

Specifications/技术参数

Number of contacts/芯数	2+PE	3+PE
Termination/接线方式	moulded on cable/成型线	
Wire gauge/线规	max. 1.5mm ² (max.16 AWG)	
Operating temperature/工作温度	-40°C~+80°C	
Mechanical operation/插拔次数	> 100 mating cycles	
Rated voltage/额定电压	630V	
Rated current (40°C)/额定电流	12A	
Protection degree/防护等级	IP67/IP68	
Contact resistance/接触电阻	≤3mΩ	
Insulation resistance/绝缘电阻	≥100MΩ	
Pin contact/插针材料	CuZn	
Socket contact/插孔材料	CuSn	
Contact plating/针孔镀层材料	Au	